

# ControlMaster

## CM30 ControlMaster universal PID controllers in cascade control applications



Measurement made easy

ControlMaster CM30

### Introduction

In a simple control loop, information from the measuring device is sent to a controller. The controller sends the information to the final control device. As a result, the measuring device detects this change in process again.

The controller function is to provide the applicable amount of feedback to make sure that the process variable stabilizes over time.

Cascade control is used to describe a signal from one controller connected to a setpoint from another, with each controller measuring a different process variable. The first controller is called the 'master' and it provides instructions to the second controller called the 'slave' via a remote setpoint signal.

A cascade control system consists of 2 control loops set inside one another. Refer to Figure 1.

In the cascade control system, the secondary process variable is adjusted according to the needs of the primary process variable. The secondary process variable must respond faster to process changes than the primary process variable.

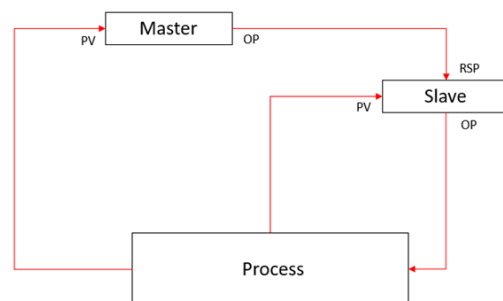

Figure 1 Cascade Control Loops

Sales



Service



## Where is cascade used

There are a number of applications where cascade control is used since standard single loop control does not provide enough accurate control. This is due to an additional variable in the process that has an effect on the primary variable being controlled. Some examples of these types of applications are:

### Reactor vessels

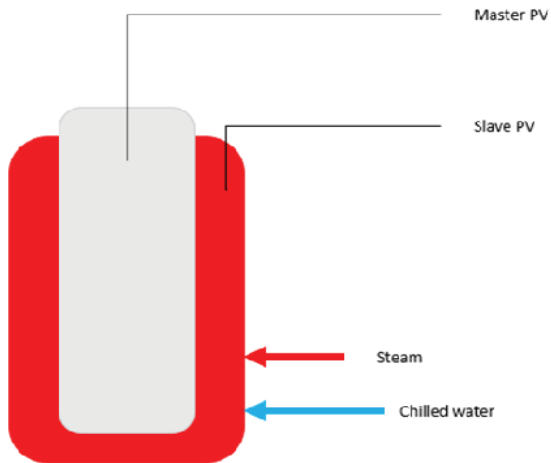

Reactor vessels are used in a number of industries including chemical and pharmaceutical industries. A jacketed reactor vessel is a container that is designed for controlling the temperature of its contents by using a cooling and/ or heating jacket around the vessel through which a cooling or heating fluid is circulated. Their primary use is for steam heating of processes which have an exothermic reaction. An exothermic reaction refers to a process where the reaction taking place releases heat. Because of this the temperature control is more difficult as the heat produced by the process itself will have an effect on the control. In order to maintain good control of the process a cascade loop is used to control the temperature of the vessel contents as the master Process variable, while using the temperature of the jacket itself as the slave process variable.

### Drum level control

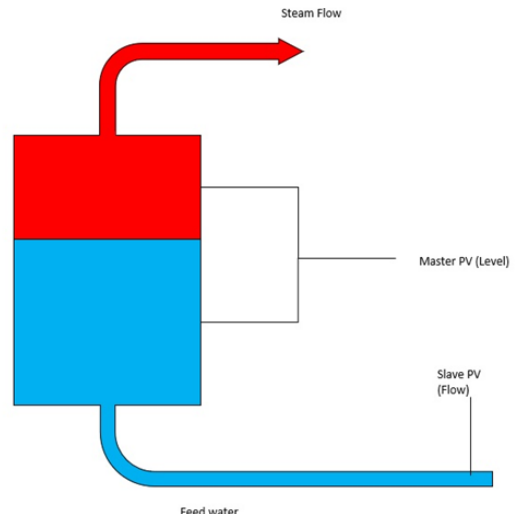

Steam boilers are a common application used in many places across plants in a variety of industries. The main requirement here is to control the level of water in the boiler drum. There are 3 common ways to do this referred to single element, two element and three element drum level control. The example here shows how cascade is used in drum level control.

The Master PV is the level of water in the boiler drum, which needs to be controlled to a constant level to ensure the boiler continues to operate correctly. It also monitors the feedwater flow into the boiler. A third variable can also be monitored as a feedforward variable in the form of the steam flow out of the boiler, which while not directly part of the cascade configuration helps to account for changes in the demands of the boiler from the plant.

## Heat Exchanger

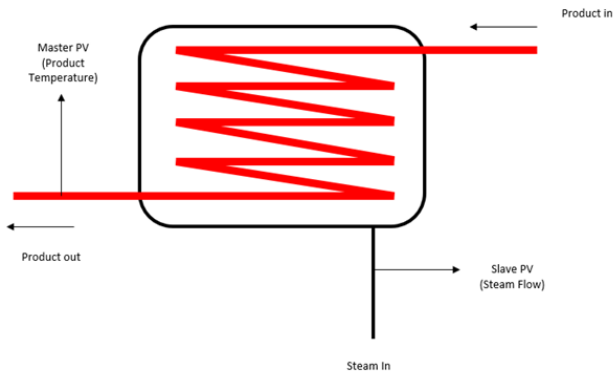

A heat exchanger is a system which is used to transfer heat between 2 or more fluids and can be used for both heating and cooling processes. There are a number of different types of heat exchanger available. This diagram shows a heat exchanger where steam is passed into the heat exchanger to heat a fluid passing through pipes internally.

Here the master PV is the product temperature and the slave PV is the steam flow into the heat exchanger, which is the controlled variable.

## ...1 Where is cascade used

### Configuring the ControlMaster for cascade control

Configuration of the controller begins in the same way as any other process.

First you must select your application template:

- 1 Enter the Device setup page:



- 2 Select Initial setup

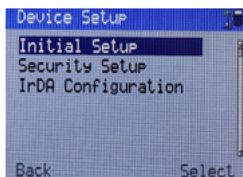

- 3 Select Application template

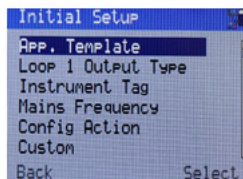

- 4 Choose the desired cascade template

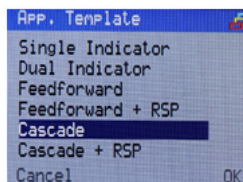

- 5 Press back and select the control output type

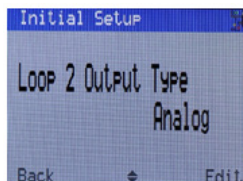

**Configure the inputs to the desired settings.**

As part of the application template the I/O of the controller will be configured automatically as shown:

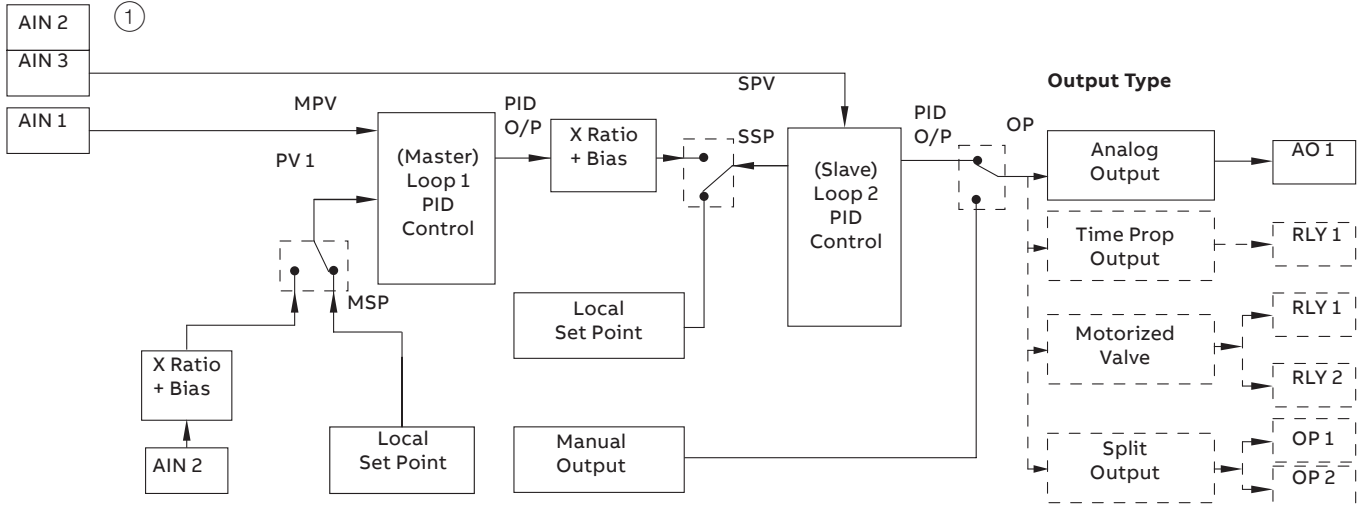

① Cascade with Remote Stepoint Only

As part of the cascade logic, logic equation 1 is pre configured.

It is important that the logic equation is not changed in any way as changes will prevent correct operation of the cascade application template, the pre-configured setup is detailed shown below:

1 Operand 1, Loop 2 Auto Mode.

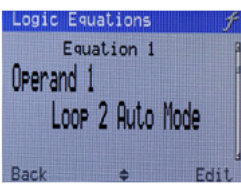

2 Invert 1, No selected.

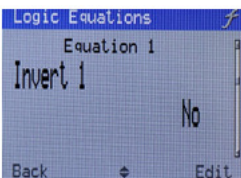

3 Operator 1, NAND selected.

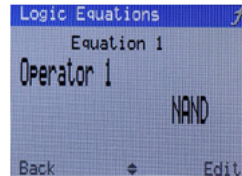

4 Operator 2, Loop 2 SP Mode selected.

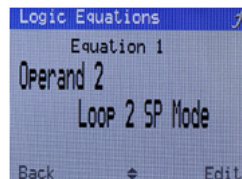

5 Invert 2, No selected.

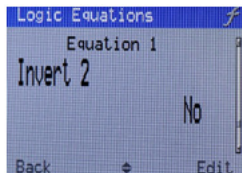

6 Operator 2, END selected.

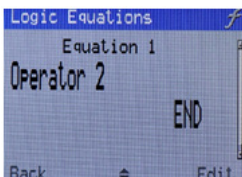

## ...1 Where is cascade used

### Tuning the cascade control loop

When tuning a cascade control loop it is important to note that you need to tune both loops separately starting with the Master control loop.

Tuning begins in the same ways as any other process:

- 1 Start by the Control page and selecting the Loop 2 (slave) control

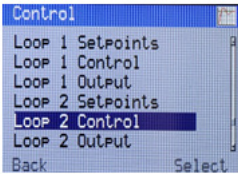

- 2 Select the type of control you wish to use

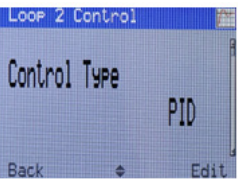

- 3 Configure the PID settings for the Slave loop

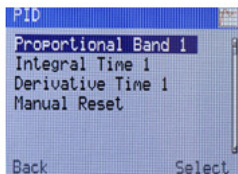

- 4 Return to the control page menu using the back button and select Loop 1 (Master) control option

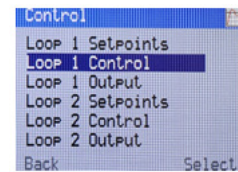

- 5 Select the type of control you wish to use

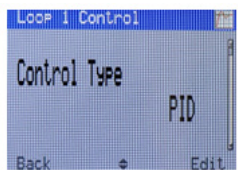

- 6 And configure the PID settings for the Master loop

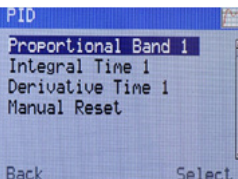

It is also possible to tune the controller using the autotune functionality. The loops must be tuned independently from each other and the Master loop must be tuned first.

### Operation of a cascade control loop

- 1 Once the controller is configured operation of the cascade control is simple. Both the master and slave control loop are displayed on the front panel:



- 2 The Master loop is displayed on the left hand side of the display and the slave loop on the right hand side. Each loop has individual Auto/ manual settings which can be changed from the operator menu:



- 3 The output of the master loop is not shown on the display in the master loop as it is bought into the slave loop as a remote setpoint and has ratio and bias applied to it. This is indicated on the front panel as the slave loop setpoint and the setpoint status of the slave loop is indicated with the local/ remote icon:

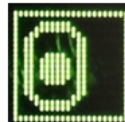

- 4 Adjustment of the local setpoints for both loops can also be performed via the operator menu:



- 5 There are also 4 operator displays available to select from which allows display of the master and slave loop individually. These can be selected via the operator menu:

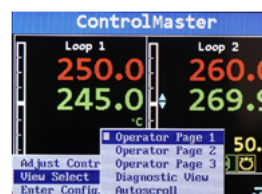

## Benefits of cascade control

The benefits of using the Controlmaster and cascade control in these types of applications are:

### Simple to configure

- Dedicated application template, for simple configuration of internal function blocks and operation.

### Dedicated operator displays

- Up to 4 operator displays including dedicated dual loop display, to show both master and slave loop on a single screen.

### Minimises process disturbances

- Allows for tighter control of processes where the primary variable can be affected by disturbances within the process, and as such limits these disturbances.

---

**ABB Measurement & Analytics**

For your local ABB contact, visit:  
**[www.abb.com/contacts](http://www.abb.com/contacts)**

For more product information, visit:  
**[www.abb.com/measurement](http://www.abb.com/measurement)**

---

We reserve the right to make technical changes or modify the contents of this document without prior notice. With regard to purchase orders, the agreed particulars shall prevail. ABB does not accept any responsibility whatsoever for potential errors or possible lack of information in this document.

We reserve all rights in this document and in the subject matter and illustrations contained therein. Any reproduction, disclosure to third parties or utilization of its contents – in whole or in parts – is forbidden without prior written consent of ABB.

© Copyright 2022 ABB.  
All rights reserved.