

SST™ Profibus Remote Module SST-PB3-REM

User Reference Guide

Document Edition: 1.1.4.0

Document #: 715-0106



Revision History

Date	Author	Changes	Revision
May 03, 2011	-	First release	1.0.0.0
September 23, 2011	-	Updated CD contents with the 64-bit version of Windows installation. Updated business name and address information. Added PNO certification information. Section 9: added note about the use of mixed DP-V0 master and slave configurations.	1.1.0.0
June 26,2012	-	Updated section RED SF LED state in section 4.2. Update flashing yellow state on p.30. Add Chapter 12 for troubleshooting.	1.1.1.0
August 1,2013	-	Correct preface section, updated 3.2,4.2,4.2.2,added sections 4.2.4, 4.2.6, updated 4.3,4.4,4.5.1, **Chapter 5 updated to mention EDS AOP and includes all updates that were done for IP67 PB3-REM	1.1.2.0
September 20,2013	-	Address mantis issues 3205, 3206, 3682, 3211, 3214, add 4.5 for upload configuration. Address reviewer comments	1.1.3.0
May 14,2014		Update section 14.4 Getting Help with link to web site	1.1.4.0

COPYRIGHTS and TRADEMARKS

This document and its contents are the proprietary and confidential property of Molex Inc. and/or its related companies and may not be used or disclosed to others without the express prior written consent of Molex Inc. and/or its related companies.

SST is a trademark of Molex Inc. All other trademarks belong to their respective companies.

At Molex, we strive to ensure accuracy in our documentation. However, due to rapidly evolving products, software or hardware changes occasionally may not be reflected in our documents. If you notice any inaccuracies, please contact us (see Chapter Warranty and Support).

Written and designed at:

**Molex Incorporated
216 Bathurst Drive
Waterloo, Ontario, Canada N2V 2L7**

Hardcopies are not controlled.

Contents

Preface	ix
System Overview.....	13
1.1 Key Features	14
1.2 How It Works	15
1.3 EtherNet/IP Assemblies Overview	16
1.4 Profibus to EtherNet/IP Data Mapping	18
1.5 Explicit Messaging Overview	19
1.6 Module States	19
1.6.1 PB3 State.....	20
1.6.2 PLC Connection State.....	20
1.6.3 Profibus State	21
Installation	23
2.1 Introduction	24
2.2 Package Contents.....	24
2.3 Installing the software	24
2.4 Equipment and Tools.....	26
Hardware Features	27
3.1 Introduction	28
3.2 System LEDs	30
3.3 Ethernet LEDs	33
3.4 Setting the IP Address, Rotary Switches.....	35
3.5 SST-PB3-REM Module Mounting	37
3.6 Ground Connection.....	38
3.7 Profibus Connection	39
3.8 Ethernet Connection	41
3.9 Power Supply.....	42

3.10	Electrical Characteristics	44
3.11	Hardware Standards	45
3.12	Condition of Use	46
Software Features		47
4.1	Introduction	48
4.2	Configuring SST-PB3-REM as a DP-V0 Master	49
4.2.1	Communication Path Configuration	59
4.2.2	Master Parameters Configuration	61
4.2.3	Device Data Area Configuration	63
4.2.4	When using raw mode (manually assign) for the REM I/O mapping mode)	67
4.2.5	Device Standard Parameters Configuration	68
4.2.6	Device Extended Parameters Configuration	69
4.2.7	Device DP-V1 Configuration	70
4.3	Online Browsing with DP View	71
4.4	Downloading Configuration	73
4.5	Uploading Configuration	75
4.6	Exported L5X File Contents	77
4.6.1	Master Configuration UDT	77
4.6.2	AOIs	78
4.7	Commands	80
4.7.1	Print Preview	80
4.7.2	Get Offset Listing	80
4.7.3	Save L5X File	81
4.7.4	Download Firmware	81
4.7.5	Upload Configuration from Flash	82
4.7.6	Erase Configuration	83
4.7.7	Online	83
4.7.8	Offline	83
4.7.9	Get/Set IP Address	84
4.7.10	Module Diagnostics	85
4.7.11	Export Binary	89
4.7.12	Import Binary	89
4.7.13	Device I/O Data	92
4.8	Connecting to Configured Master	92
4.9	Diagnosing Slave Errors	93
4.9.1	Station Non Existent	93
4.9.2	Configuration Data Fault	94
4.9.3	Station Not Ready	94
4.9.4	Extended Diagnostic Data	94
4.9.5	Function Not Supported	94
4.9.6	Invalid Slave Response	94
4.9.7	Parameter Fault	94
4.9.8	Master Lock	94
4.9.9	Param/Config Required	94
4.9.10	Static Diagnostics	95

4.9.11	DP Slave Set	95
4.9.12	WatchDog.....	95
4.9.13	Ext Diags Overflow	95
Configuring the SST-PB3-REM Profibus Master in RSLogix5000.....		97
5.1	RSLogix5000 Configuration Overview.....	98
5.2	Configuring the SST-PB3-REM as a Generic EtherNet/IP CIP Bridge.....	98
5.3	Registering SST-PB3-REM EDS file.....	106
5.3.1	Registering EDS file via Upload EDS file from device using RSLinx	106
5.3.2	Registering EDS file via EDS Hardware Installation Tool	112
5.4	Changing the Ethernet Port Configuration of the SST-PB3-REM in RSLinx.....	117
5.5	Configuring the SST-PB3-REM in Studio 5000 V21 using EDS AOP (Add-On-Profile).....	120
5.5.1	Configuring Remote Module as DP Master only via EDS AOP	124
5.5.2	Configuring Remote module as Slave only via EDS AOP.....	127
5.5.3	Configuring the Remote Module as Master and Slave via EDS AOP.....	130
5.5.4	Configuring the RPIs for all configured connections	134
5.5.5	Selecting the Module Info Tab	135
5.5.6	Configuring the IP Settings and configuration via EDS AOP	136
5.5.7	Selecting the Port Configuration Tab in EDS AOP.....	137
5.6	Importing the L5X File into RSLogix5000	139
5.7	Using Provided AOIs.....	146
5.8	PLC Connection Error Codes	156
EtherNet/IP Assemblies		157
6.1	Exclusive Owner.....	158
6.1.1	I/O Assemblies.....	158
6.1.2	Configuration Assemblies.....	160
6.2	Input Only.....	161
6.3	Making Changes to the Configuration Assembly.....	165
System Diagnostics		167
7.1	Profibus Status Register.....	168
7.1.1	Firmware Version Number	169
7.1.2	DP Master Live List and Diagnostics List.....	169
7.1.3	Reading the Slave Diagnostics.....	173
7.2	Diagnostic Counters	174
7.2.1	General Statistics	176
7.2.2	DP Master Statistics.....	176
7.2.3	ASPC2 Profibus Controller Statistics	177
Slave Functionality.....		179
8.1	DP Slave Features.....	180
8.2	Status Assembly Entries	180
8.3	Slave Configuration.....	181

Explicit Messaging	183
9.1 General Overview of Explicit Messaging	184
9.1.1 Sending Explicit Messages to the DP-V1 Object	184
9.1.2 Sending Explicit Messages to the Command Object.....	185
9.1.3 Sending Explicit Messages to the Assembly Object.....	185
9.1.4 Sending Explicit Messages to the Basic Diagnostics Object.....	186
9.2 DP-V1 Explicit Messaging.....	186
9.2.1 DP-V1 Class 1 Read Command.....	186
9.2.2 DP-V1 Class 1 Write Command.....	188
9.2.3 DP-V1 Initiate Command	189
9.2.4 DP-V1 Class 2 Abort Command.....	192
9.2.5 DP-V1 Class 2 Read Command.....	193
9.2.6 DP-V1 Class 2 Write Command.....	194
9.2.7 Extended Error Code.....	195
9.2.8 Get Slave Diagnostics	196
9.2.9 Disable / Enable Slave	197
9.2.10 Set Slave Address	198
9.2.11 Basic Diagnostics	199
9.3 Sending an Explicit Message to SST-PB3-REM in RSLogix5000.....	201
RSLogix5000 Ladder Samples	207
10.1 Ladder Sample Overview.....	208
10.2 DP-V0 Master Ladder Sample	208
10.3 DP-V0 Slave Only Ladder Sample	208
10.4 DP-V1 Class 1 and Class 2 Master Ladder Sample.....	208
Troubleshooting	209
11.1 Troubleshooting	210
Technical Specifications	213
CE Compliance	215
Warranty and Support	217
14.1 Warranty.....	218
14.2 Reference Documents	218
14.3 Technical Support	218
14.4 Getting Help.....	219

Preface

Chapter Sections:

- Purpose of this Guide
- Special Notation
- Acronyms

Purpose of this Guide

This manual is a user's guide for the SST-PB3-REM Profibus Remote Module. Use this guide if you are responsible for installing, programming or troubleshooting control systems that use Allen-Bradley Logix™ processors with SST-PB3-REM. It is assumed that you have a basic understanding of PLCs and are familiar with Profibus modules and the Profibus network.

Special Notation

The following special notations are used throughout this guide:



Warning

Warning messages alert the reader to situations where personal injury may result. Warnings are accompanied by the symbol shown, and precede the topic to which they refer.



Caution

Caution messages alert the reader to situations where equipment damage may result. Cautions are accompanied by the symbol shown, and precede the topic to which they refer.



Note

A note provides additional information, emphasizes a point, or gives a tip for easier operation. Notes are accompanied by the symbol shown, and follow the text to which they refer.

Acronyms

For the purposes of this user reference guide, the following abbreviations apply.

Abbreviation	Meaning
AOI	RSLogix5000 Add-On Instruction.
DP-V0/DP-V1	Decentralized Periphery Version 0/1
FDT	Field Device Tool
L5X	RSLogix5000 export file format.
PLC	Programmable Logic Controller
PNO	PROFIBUS Nutzerorganisation e.V.
ODVA	Open Device Vendors Association
RPI	Requested Packet Interval
UDT	RSLogix5000 User-Defined Data Type.

1

System Overview

Chapter Sections:

- Key Features
- How It Works
- EtherNet/IP Assemblies Overview
- Profibus to EtherNet/IP Data Mapping
- Explicit Messaging Overview
- Module States

1.1 Key Features

The SST-PB3-REM is a linking device designed to provide Profibus DP-V0 and DP-V1 Master / Slave capability to Rockwell Automation Logix™ systems via EtherNet/IP.

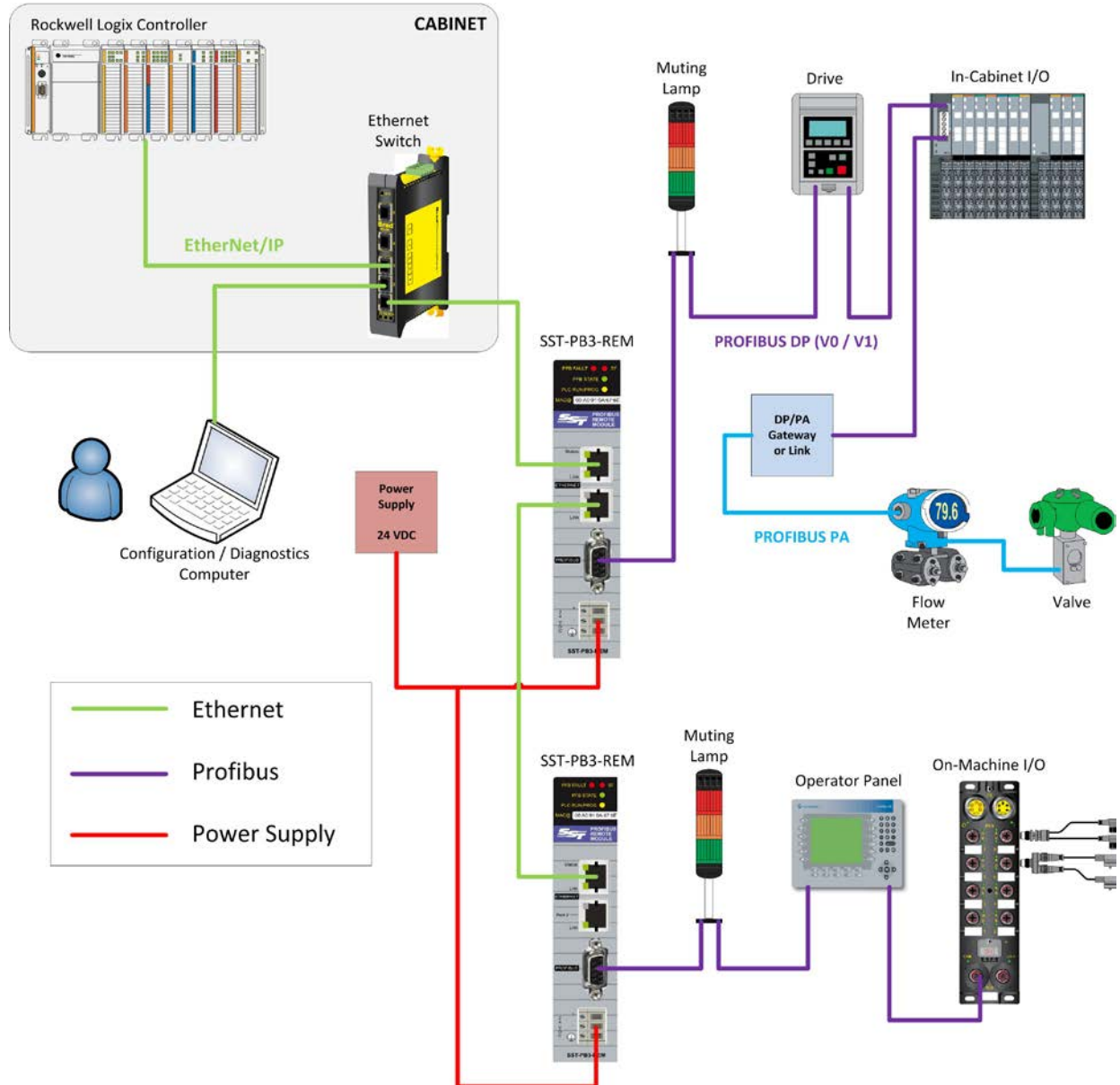

Figure 1.1-1: SST™ PB3 Remote Module Typical Application

Key features:

- Compatibility with any Rockwell Automation Logix™ controllers.
- Easier RSLogix5000 configuration using SST™ Profibus Configuration Tool exported L5X file. The L5X file contains I/O tags in UDT format with corresponding AOI(s).
- Several SST-PB3-REM modules may be connected to the same Ethernet Network.
- Two Ethernet ports with an embedded switch feature.

- Supports up to five Listen-only connections.
- Supports Explicit Messaging for retrieving status and diagnostics information, as well as I/O data.
- Windows engineering console to configure and diagnose Profibus network and devices.
- Includes a CommDTM driver to provide transparent access from FDT software such as FactoryTalk® AssetCentre, PACTware™, FieldCARE™ or asset management tools to the Profibus devices.
- EtherNet/IP Adapter ODVA certified.
- PNO certified: Profibus DP-V0, V1 Master and DP-V0 Slave.
- Profibus features:
 - Acts as Profibus DP-V0 and DP-V1 Master.
 - Acts as Profibus DP-V0 Slave.
 - Able to run Profibus DP-V0 Master and Slave modes simultaneously.
 - Supports all standard Profibus baud rates (9.6Kbps to 12Mbps).
 - As Profibus DP-V0 Master is able to scan up to 125 devices slave devices with a total of 1996 bytes input and 1980 bytes output data.
 - As Profibus DP-V0 Master supports and scans up to 244 bytes of input data and 244 bytes of output data per slave.
 - As Profibus DP-V0 Master supports Sync and Freeze commands.
 - Supports the following DP-V1 Master services:
 - Class-1: MSAC1_Read, MSAC1_Write
 - Class-2: MSAC2_Initiate, MSAC2_Read, MSAC2_Write, MSAC2_Abort

1.2 How It Works

SST-PB3-REM combines the functionality of an EtherNet/IP Adapter with that of a Profibus Master or/and Slave which enables a controller acting as an EtherNet/IP Scanner to transmit and receive data on the Profibus network.

There are four possible communication paths between the EtherNet/IP Scanner and the Adapter embedded in the PB3 Remote Module:

- Exclusive Owner connection(s) for I/O exchange.
- Input-only connection for retrieving status information. When configuring an Exclusive Owner connection in RSLogix5000 this connection is automatically opened when the user selects Data SINT with Status for the “Comm Format” parameter.
- Listen-only connection(s) for monitoring. Corresponding Exclusive Owner connection(s) must exist.
- Explicit Messaging for sending various commands, DP-V1 messaging and I/O exchange. No implicit connection(s) is required.

The EtherNet/IP and Profibus scan cycles are independent from each other (see Figure 2.2-1 below).

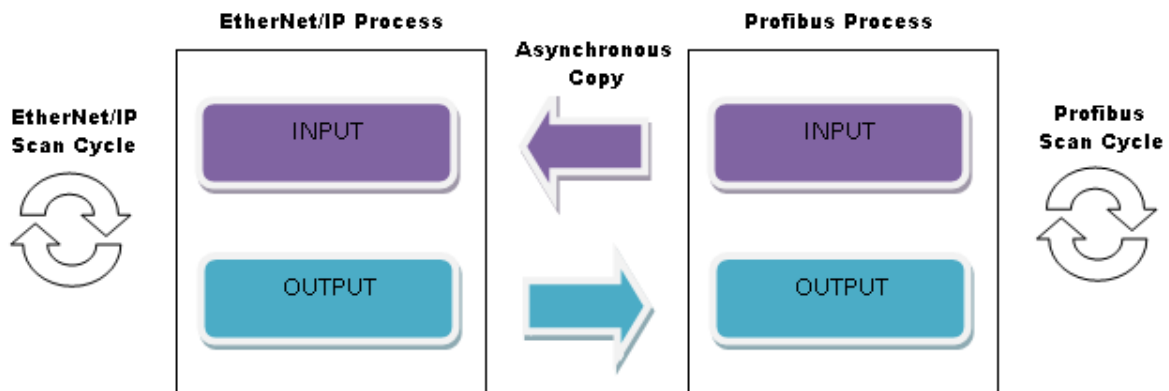

Figure 1.2-1: Data Transfer between EtherNet/IP and Profibus

Output data (O→T) is copied from the EtherNet/IP process following a data change event and it is sent on the Profibus network as part of the next Profibus scan cycle. Input data (T→O) is copied from the Profibus process at the end of the Profibus scan cycle and it is sent on the EtherNet/IP network as part of the next EtherNet/IP scan cycle. The data transfer mechanism ensures data consistency for the entire I/O image.

Input data copy latency between the Profibus and EtherNet/IP processes is maximum one EtherNet/IP scan cycle (RPI).

Output data copy latency between the EtherNet/IP and Profibus processes is maximum one Profibus scan cycle.

The recommended EtherNet/IP RPI is half the Profibus scan cycle, giving priority to input data.

While the EtherNet/IP Adapter side of the module is configured through CIP connections, the SST™ Profibus Configuration Tool is used to configure the Profibus Master functionality, see [section 4](#), Software Features for more details. The Profibus Slave functionality is configured via the EtherNet/IP configuration assemblies, see [section 9](#), Slave Functionality for more details.

1.3 EtherNet/IP Assemblies Overview

Internal to the SST-PB3-REM, Profibus data is mapped to EtherNet/IP I/O assemblies. When the module is configured as a Profibus Master, data mapping is automatically handled by the SST™ Profibus Configuration Tool at the time when the configuration is created. Based on the Profibus configuration, the user must configure at least one or up to five Exclusive Owner connections as seen in Table 2.3-1: Exclusive Owner Connections. To view data mapping in the SST™ Profibus Configuration Tool, see section 4.2.2, Master Parameters Configuration.

Table 1.3-1: Exclusive Owner Connections

Assembly Type	Connection Parameter	Assembly Instance	Data Size (in Bytes)
Master 1 st Connection – Exclusive Owner	Input	111	500
	Output	121	496
	Configuration	131	8 (or 0) *
Master 2 nd Connection – Exclusive Owner	Input	112	500
	Output	122	496
	Configuration	131	0 (or 8) **
Master 3 rd Connection – Exclusive Owner	Input	113	500
	Output	123	496
	Configuration	131	0 (or 8) **
Master 4 th Connection – Exclusive Owner	Input	114	500
	Output	124	496
	Configuration	131	0 (or 8) **
Slave Connection (when also using the Master mode) – Exclusive Owner	Input	141	244
	Output	151	244
	Configuration	131	0 (or 8) **
Slave Only Connection (no Master mode) – Exclusive Owner	Input	142	248
	Output	152	248
	Configuration	132	6
Status – Input Only	Input	161	500
	Output	171	0

(*): 0 if no configuration data is used.

(**): By default this value should be left at 0. If set to 8, configuration data must match configuration data from the first Exclusive Owner connection.

Listen-only connection refers to a connection that is made to an SST-PB3-REM module that is already configured with an Exclusive Owner connection from the main controller. A Listen-only connection allows inputs on an SST-PB3-REM module to be monitored from another controller. Up to 5 Exclusive Owner connections may be configured on the module. For each Exclusive Owner connection one Listen-only connection may also be configured, as seen in Table 2.3-2: Listen-only Connections.

When setting up a listen-only connection in RSLogix5000 the data format must be identical with the data format that is configured on the controller with the Exclusive Owner connection. Supported data formats for listen-only are:

- Input Data SINT - With Status.

- Input Data SINT.

Table 1.3-2: Listen-only Connections

Assembly Type	Connection Parameter	Assembly Instance	Data Size (in Bytes)
Master 1 st Connection – Listen Only	Input	111	500
	Configuration	131	0 (or 8) *
Master 2 nd Connection – Listen Only	Input	112	500
	Configuration	131	0 (or 8) *
Master 3 rd Connection – Listen Only	Input	113	500
	Configuration	131	0 (or 8) *
Master 4 th Connection – Listen Only	Input	114	500
	Configuration	131	0 (or 8) *
Slave Connection (when also using the Master mode) – Listen Only	Input	141	244
	Configuration	131	0 (or 8) *
Slave Only Connection (no Master mode) – Listen Only	Input	142	248
	Configuration	132	0 (or 6) **

(*): By default this value should be left at 0. If set to 8, configuration data must match configuration data from the first Exclusive Owner connection.

(**): By default this value should be left at 0. If set to 6, configuration data must match configuration data from the Slave Only Exclusive Owner connection.



Note

Listen-only connections must be configured as multicast. If the corresponding Exclusive Owner connection was previously configured as unicast, it must be disabled and reconfigured, in order for the two connection configurations to match.

1.4 Profibus to EtherNet/IP Data Mapping

As mentioned above, SST™ Profibus Configuration Tool manages the mapping of Profibus data into the EtherNet/IP I/O assemblies. Data mapping follows the RSLogix5000 rules of data representation in the memory of the Logix™ controllers. This approach allows the configuration tool to export the Profibus master configuration into an L5X file which later can be imported in RSLogix5000 (note that only version 16 or higher support AOIs contained in the L5X file).

The master configuration appears in the L5X file as a UDT, which is a collection of structures representing all Profibus slave devices and their individual modules and variables with the names defined in the SST™ Profibus Configuration Tool, for detail on variable naming see section

4.2.3, Device Data Area Configuration. To use the master configuration in the controller program, a controller tag of type master UDT must be declared.

In addition to I/O configuration the master UDT also contains the status information, mapped to the Status assembly. The status structure contains various diagnostics and module status information.

To facilitate data copy between the EtherNet/IP assemblies and the controller tag(s) of type UDT used by the ladder logic, the L5X file also contains an AOI which handles both copying of I/O data and status information.

The L5X file also contains an AOI that allows the ladder logic to verify that the L5X file being used matches the configuration present in flash. For more details on using the UDTs and AOIs see [section 4.6.2](#).

In the two instances when an L5X file cannot be used, using a non Logix™ controller or RSLogix5000 version earlier than 16, the user must be aware of the data mapping. The SST™ Profibus Configuration Tool provides an XML file with the offset listing for the master configuration. This file may be later imported into an Excel spreadsheet.

1.5 Explicit Messaging Overview

SST-PB3-REM supports two types of explicit messages: for retrieving I/O data and general messaging such as DP-V1, diagnostics data etc.

Reading and writing I/O data may be useful when the originator does not have implicit messaging capabilities. Note that once an implicit connection is established, data cannot be written via explicit messaging anymore. However data may be read from any assembly, regardless of its owned status. Reading data may be used for diagnostics and monitoring purposes.

Typically explicit messaging will be used for:

- Retrieving Profibus slave diagnostics.
- Enable/disable Profibus slave(s).
- Set Profibus slave address.
- Retrieve module basic diagnostics.
- DP-V1 Messaging.

For details see section 9, Explicit Messaging.

1.6 Module States

The SST-PB3-REM implements three states that dictate the module's behavior:

- PB3 State.
- PLC Connection State.
- Profibus State.

The states may be retrieved via:

- SST™ Profibus Configuration Tool, Diagnostics option (section 5.7.9, Module Diagnostics).
- Explicit Messaging (section 10.1.4, Sending Explicit Messages to the Basic Diagnostics Object).
- Status assembly (section 7.2, Input Only).

1.6.1 PB3 State

State	Value	Description
MASTER	1	The module is currently operating in master or master/slave mode.
NO CONF	2	No Profibus master configuration present in flash.
SLAVE	3	The module is currently operating in slave only mode.

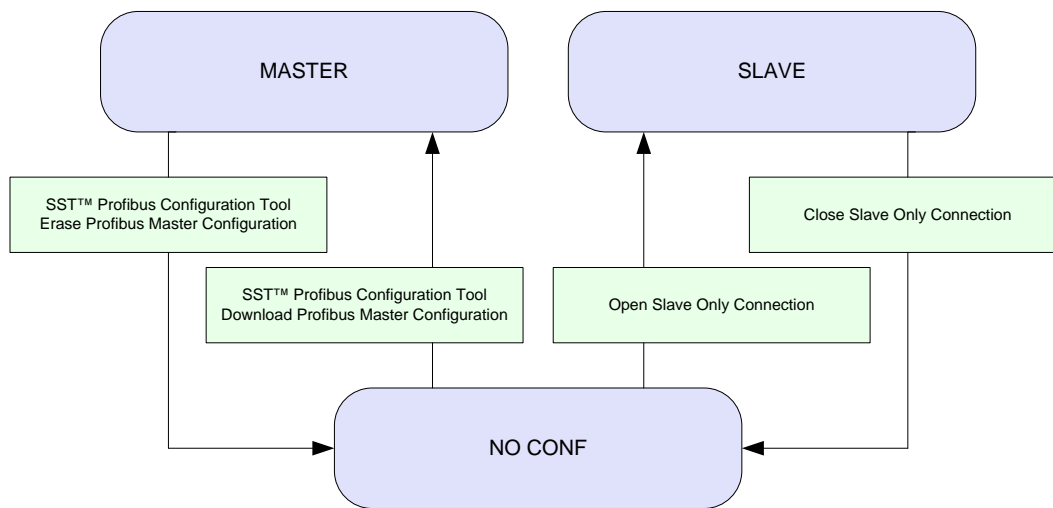

1.6-1: PB3 State Transition Diagram

1.6.2 PLC Connection State

State	Value	Description
PLC OFF	2	No Exclusive Owner connections are currently opened.
PLC PROG	3	The controller is in PROG mode or in RUN mode, but the number of Exclusive Owner connections that have been successfully opened does not match the number required by the configuration

		stored in flash.
PLC RUN	4	The controller is in RUN mode.

The diagram below illustrates an example of transitioning from PLC OFF to the other two states: PLC PROG and PLC RUN.

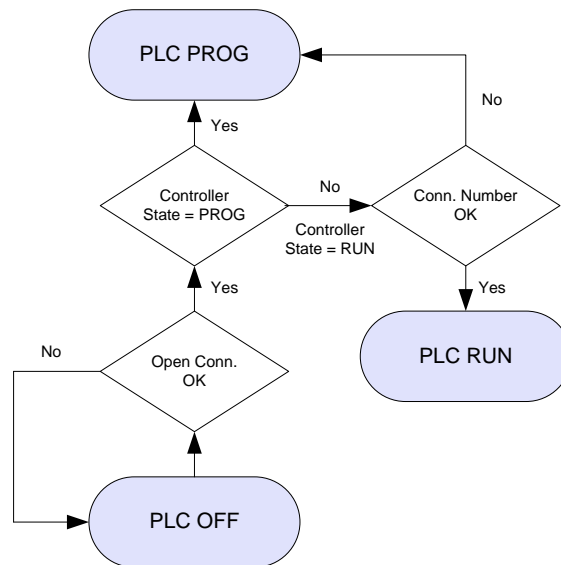

1.6-2: PLC Connection State Transitions Example

1.6.3 Profibus State

State	Value	Description
OFFLINE	1	The module is offline on Profibus.
STOP	2	A CommDTM connection to the module has been established.
OPERATE	3	As a Profibus master, the module is online on Profibus and being scanned in RUN mode by the controller (inputs and outputs are being updated). The controller is in RUN mode.
CLEAR	4	As a Profibus master, the module is online on Profibus and being scanned in PROG mode by the controller (inputs hold their last state, outputs are 0). The controller is either RUN or PROG mode.
SLAVE ONLY	5	As a Profibus slave, the module is online on Profibus.

Note that the module may be put online/offline on Profibus either through:

- SST™ Profibus Configuration Tool (see sections [4.8.7, Online](#) and [4.8.8, Offline](#)).
- Command interface with the controller , once an Exclusive Owner connection has been opened (see section 6.1.1, I/O Assemblies)

The diagram below illustrates an example of transitioning from OFFLINE to the other four states: STOP, OPERATE, CLEAR and SLAVE ONLY.

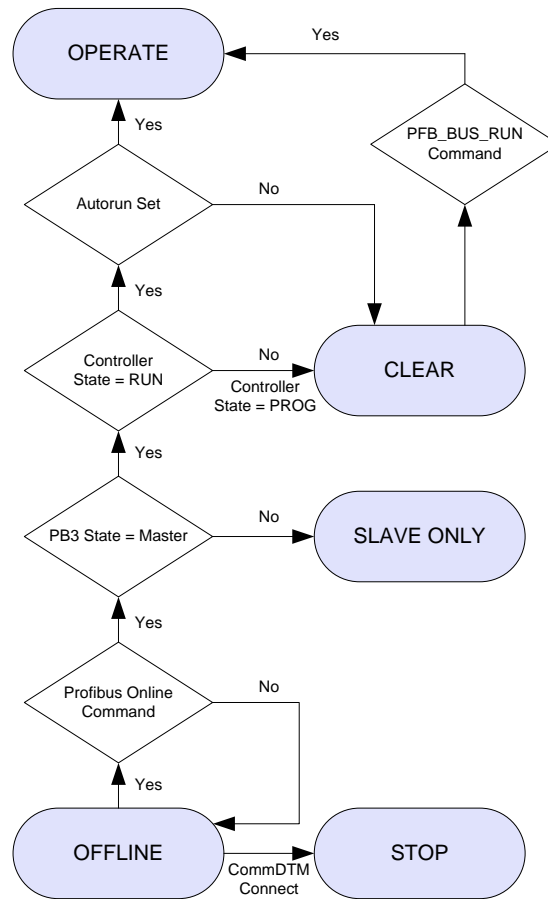

1.6-3: Profibus State Transition Example

2

Installation

Chapter Sections:

- Introduction
- Package Contents
- Installing the software
- Equipment and Tools

2.1 Introduction

The CD-ROM included in the SST-PB3-REM module packaging contains the installations for a number of different Rockwell backplane modules. To install the software for the SST-PB3-REM please follow the instructions in section 3.3, Installing the software.



Note

Ensure that any previous SST Profibus installations are uninstalled and reboot the PC before installing a new version of the software.

2.2 Package Contents

The contents include:

- One SST-PB3-REM module
- CD with files for Windows 32-bit and 64-bit installation (Windows XP/Server 2003/Vista /Server 2008 and Windows 7) and this manual.

2.3 Installing the software

1. Insert the installation CD-ROM into the CD or DVD drive of the computer.
2. A menu should be automatically opened. If this is not the case, open the CD root with Windows Explorer, and execute autorun.exe.
3. Select Product Menu from the list.

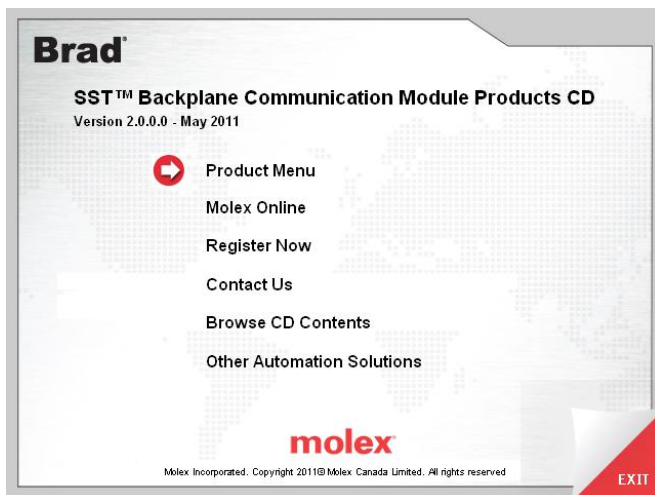

4. Select SST-PB3-REM from the list.

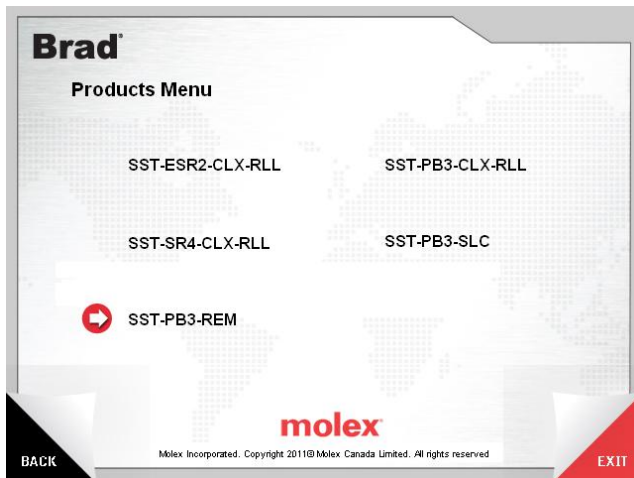

5. Select SST Profibus Backplane Products Install x.x for Windows and click Install.

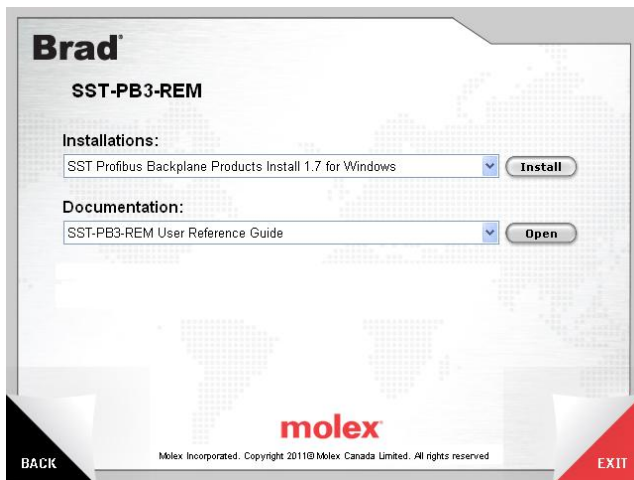

6. Click on Next >
7. Read the License agreement and if you agree, click the acceptance and Next >.
8. Fill in the appropriate responses and click Next >.
9. Click Finish.
10. The system must be re-started to use the Profibus software.

2.4 Equipment and Tools

At a minimum, have the following tools and equipment ready:

- SST-PB3-REM module
- 24V power supply
- Profibus cable to connect the SST-PB3-REM to the Profibus network
- 2 Profibus DB-9 connectors
- 1 RJ45 Ethernet cable
- SST™ Profibus Configuration Tool
- Rockwell CompactLogix or ControlLogix PLC
- Rockwell RSLogix5000 version 16 or later

3

Hardware Features

Chapter Sections:

- Introduction
- System LEDs
- Ethernet LEDs
- Setting the IP Address, Rotary Switches
- SST-PB3-REM Module Mounting
- Ground Connection
- Profibus Connection
- Ethernet Connection
- Power Supply
- Electrical Characteristics
- Hardware Standards
- Condition of Use

3.1 Introduction

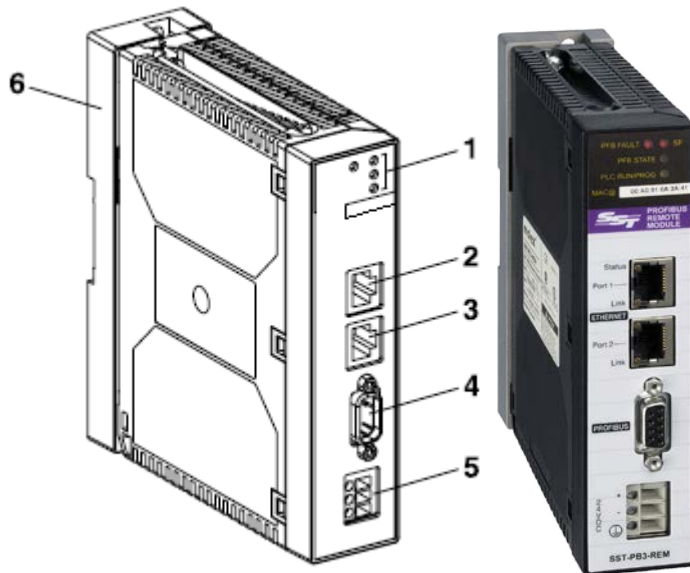

Table 1: Description of Features

Reference	Description
1	4 LED indicators
	- System fault detected
	- Profibus fault detected
	- Profibus State
	- PLC RUN/PROG state
2 and 3	RJ45 connectors for Ethernet link (integrated switch)
4	9-pin D-SUB connector for Profibus link
5	Screw terminal for 24 VDC power supply connection
6	Support plate for fixing the module directly to a DIN rail

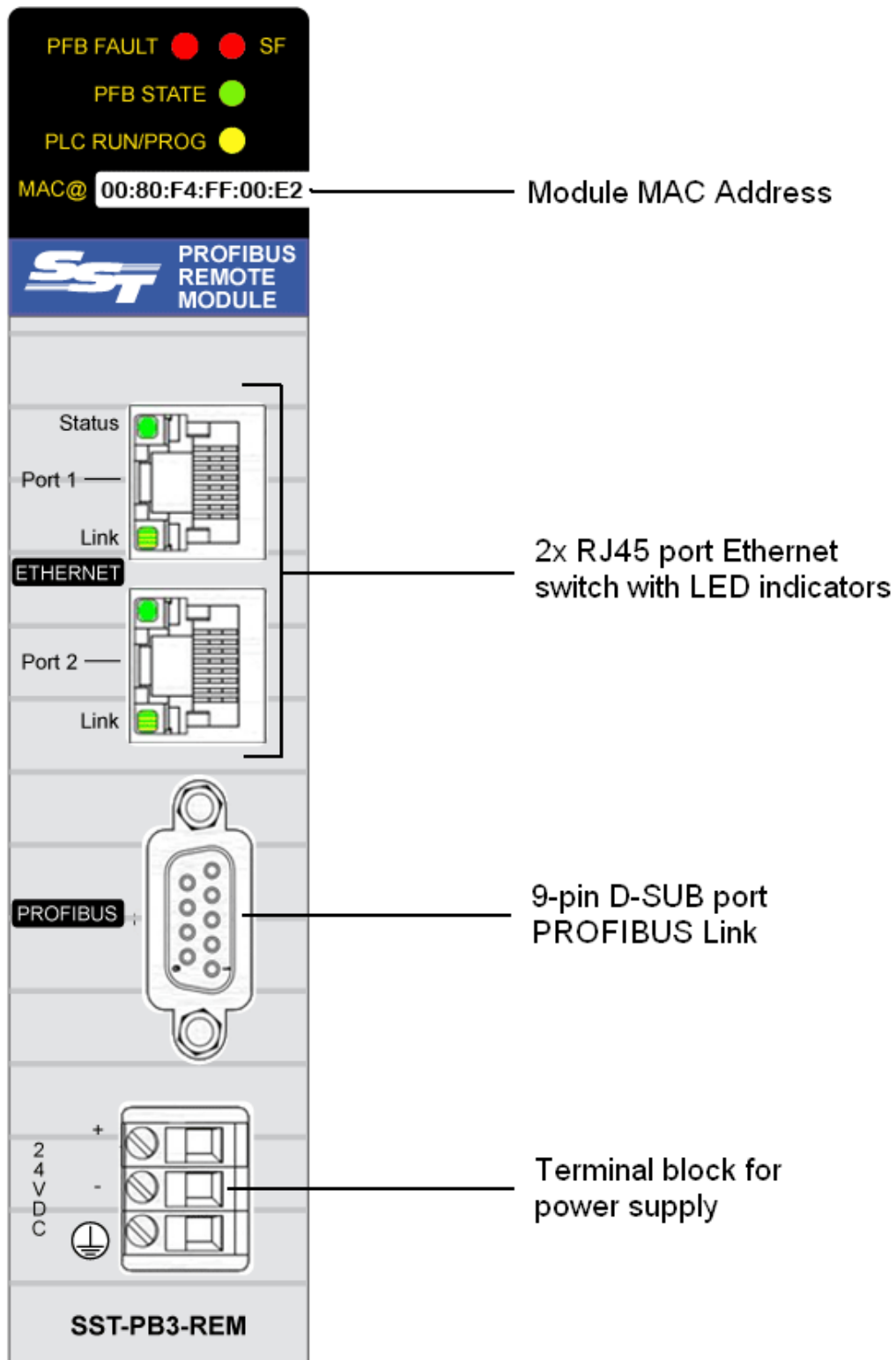

Figure 1:

3.2 System LEDs

This section describes the behavior of the system LEDs.

PFB FAULT: Profibus Fault

SF: System Fault

PFB STATE: Profibus State

PLC RUN/PROG: PLC State

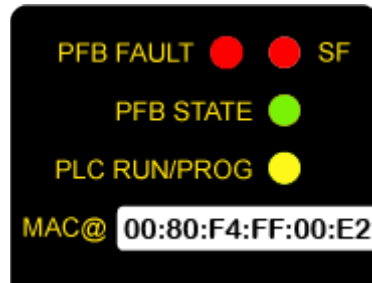

SF (System Fault)

LED State	Description/Meaning
Solid Red	<p>Boot up and fault state.</p> <p>Following a soft or hard reset, the LED remains in this state until the end of the boot up sequence. If the power is cycled on the module with the Ethernet cable unplugged, the SF LED will remain Solid Red. The module must be connected to Ethernet and assigned an IP Address before communication is possible.</p> <p>When the module is powered up for the very first time, an IP address must be assigned by a DHCP server before the module can finish its boot up sequence and change the Solid RED SF LED to a flashing RED LED state. The default configuration mode is DHCP. You have the option of using Rockwell's BOOTP-DHCP Server to assign an IP Address to the module.</p> <p>If an IP address has been assigned successfully and it continues to stay in solid RED SF LED state, then an unrecoverable fault has been detected, either at the hardware or firmware</p>

	<p>level.</p> <p>To recover from this state the module must be rebooted. For more trouble-shooting details see Chapter 11: Troubleshooting.</p> <p>In this state the Profibus LEDs, PFB FAULT and PFB STATE, are off. In some situations PFB FAULT may indicate a reason for failure.</p> <p>If power is cycled with Ethernet cable disconnected the SF LED will remain solid Red. After reconnecting the Ethernet cable to the module Ethernet communication should commence once it has an IP address.</p>
Flashing Red	<p>Normal operation state.</p> <p>No unrecoverable fault detected.</p> <p>There is no Profibus master configuration present in flash and Profibus slave only functionality is not started on the module.</p>
Off	<p>Normal operation state.</p> <p>No unrecoverable fault detected, both hardware and firmware are running without errors.</p> <p>A valid Profibus master configuration file is present in flash.</p>

PFB FAULT (Profibus Fault)

LED State	Description/Meaning
Flashing Red	<p>In master mode may indicate that at least one of the devices in the scan list is in error or offline.</p> <p>If configured, local slave is in error.</p> <p>May indicate network errors:</p> <ul style="list-style-type: none"> - Network timeout errors – occur when no activity is detected on the Profibus network. - Double token errors – occur when multiple nodes behave as token holders simultaneously. It may also indicate wiring problems, duplicate nodes, etc.

	<ul style="list-style-type: none"> - General network errors – occur when there are problems on the network but not severe enough to cause a network timeout error. - Duplicate station errors – occur when a duplicate station is detected. - Pass token errors – occur when the module is unable to pass the token. Usually caused by bad wiring (shorted) or other hardware problems.
Off	Communication with all the devices in the scan list is OK, there are no network errors, or the module is offline on the Profibus network.
Solid Red	Duplicate active station address detected.

PFB STATE (Profibus State)

LED State	Description/Meaning
Solid Yellow	Profibus Stop Mode.
Flashing Yellow	Slave Only Mode – the module is being scanned in Clear or Operate mode by a DP Master.
Flashing Green	Profibus Clear Mode.
Solid Green	Profibus Operate Mode.
Off	Profibus Offline Mode.

PLC RUN/PROG

LED State	Description/Meaning
Off	PLC is off – there is no EtherNet/IP connection between the module and PLC.
Flashing Yellow	PLC is in PROG mode – EtherNet/IP connections are in idle state.
Solid Yellow	PLC is RUN mode.

3.3 Ethernet LEDs

This section describes the behavior of the Ethernet LEDs.

Status: IP Addressing Status

Link: Ethernet Link

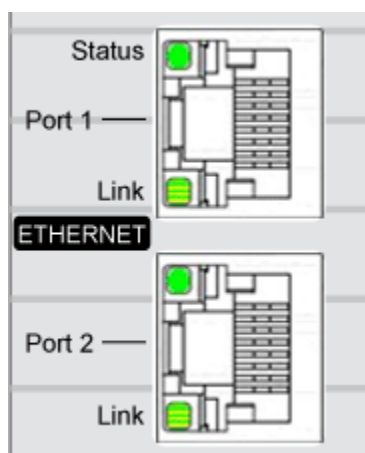

Status (IP Addressing Status)

LED State	Description/Meaning
Off	Initial state.
On	<p>The module successfully started with an IP address defined by the rotary switches (with the exception of factory IP address, 192.168.1.1).</p> <p>The LED remains in this state until reboot unless the module started with the factory IP address and a duplicate IP address condition is detected at run time, in which case the LED state changes to 5 flashes.</p>
2 Flashes	<p>The module successfully started with factory IP address. This occurs when the lower rotary switch is in position A or B.</p> <p>The LED remains in this state until reboot unless a duplicate IP address condition is detected at run time, in which case the LED state changes to 5</p>

	flashes.
3 Flashes	The module is waiting for reply from a DHCP server. The LED remains in this state until a valid reply is received from the DHCP server.
5 Flashes	Duplicate IP address detected. A duplicate address may be detected both at startup and during runtime. The LED remains in this state until reboot. The SF LED is solid red in this case.
6 Flashes	This occurs when: <ul style="list-style-type: none"> - Lower rotary switch is in position F, recovery mode. - Lower rotary switch is in position E, erase configuration file. <p>The LED remains in this state until reboot. The SF LED is solid red in this case.</p>

Link (Ethernet Link State)

LED State	Description/Meaning
Off	No Link.
Solid Green	Speed 100 Mbps, no network activity detected.
Flashing Green	Speed 100 Mbps, network activity detected.
Solid Yellow	Speed 10 Mbps, no network activity detected.
Flashing Yellow	Speed 10 Mbps, network activity detected.

3.4 Setting the IP Address, Rotary Switches

IP Addresses Assignment To avoid duplicate IP address condition, before connecting SST-PB3-REM to the Ethernet network, it is recommended to identify all existing Ethernet devices on the network along with their IP addresses and assign IP addresses to new devices. If necessary, the IP, gateway and subnet mask addresses of the module may be changed using Get/Set IP Address feature in the SST™ Profibus Configuration Tool, see section 4.8.9, Get/Set IP Address for details.

Rotary switches The rotary switches are on the back of the module and must be set up prior to mounting the SST-PB3-REM module. Once the module is mounted, they will no longer be accessible.

The primary role of the rotary switches is to define the SST-PB3-REM IP address assignment modes.

- DHCP based on MAC address
- DHCP based on hardware name **SST_PB3_XXX**
- Static fixed (192.168.1.1)
- Static configurable (192.168.1.x)
- Stored in Flash

The factory default setting is configured to use **DCHP based on MAC address**. The MAC address is written on the front panel of the module.

Two additional modes may also be triggered in some specific cases:

- **Clear IP:** used to erase the Profibus DP master configuration file and stored IP address.
- **Recovery:** used in extreme cases when the firmware image in flash becomes corrupt. To be used with the assistance of technical support only.

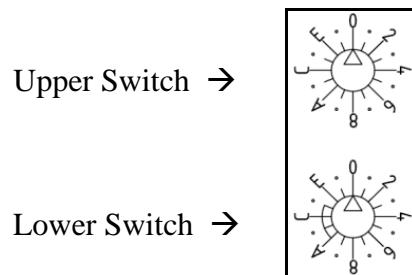

Switch	Position	Descriptions/Meaning
Upper	0-9	Tens value for the device name (0, 10, 20, ... 90).
	A to F	Tens value for the device name (100, 110, ... 150).
Lower	0-9	Ones value for the device name (0, 1, 2, ... 9). <u>Mode</u> : DHCP with device hardware name (SST_PB3_REM_xxx) where xxx = upper switch setting x 10 + lower switch setting (<=9) (always in three digit format). E.g.: if upper Switch = 1 and lower Switch = 2, then hardware name = SST_PB3_REM_012.
	A	<u>Mode</u> : Factory IP: 192.168.1.1
	B	<u>Mode</u> : Factory IP: 192.168.1.x where x = upper switch setting Note that if the upper switch is set to either 0 or 1, the IP address is 192.168.1.1.
	C	<u>Mode</u> : Flash IP assignment. Data stored in flash is used to determine the IP address assignment. There are two possible options: - Via DHCP. - Static IP address.
	D	<u>Mode</u> : DHCP based on MAC address.
	E	Configuration file deletion.
	F	Recovery scenario.



Note

The factory default settings are: upper switch **0**, lower switch **C**.

The rotary switches position is read at power up only.

3.5 SST-PB3-REM Module Mounting

At a glance

Using its support plate, the SST-PB3-REM module may be installed as a standalone module on a DIN rail, grid or panel.

Support plate

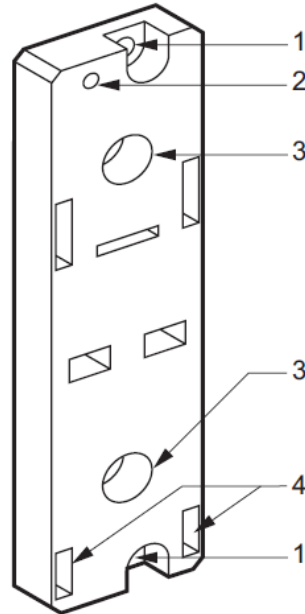

Label	Meaning
1	Two holes of diameter 5.5 mm (7/32 in) allowing the support plate to be fixed to a panel or to an AM1-PA pre-slotted plate, with a centerline distance of 140 mm (5.51 in). Tightening torque: 1 to 1.2 N-m (8.8 to 10.6 lb-in).
2	M4 fixing hole for securing the SST-PB3-REM module.
3	Two holes of diameter 6.5 mm (0.26 in) allowing the support plate to be fixed to a panel or to an AM1-PA pre-slotted plate with a centerline distance of 88.9 mm (3.5 in).
4	Slots for positioning the pins located at the bottom and rear of the module.

3.6 Ground Connection

Grounding the SST-PB3-REM Module

Field Earth (FE) is available on the power connector in order to discharge high frequency noise.

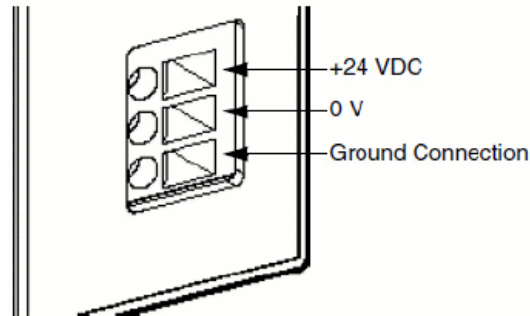

The module is grounded using the metal plates situated at the rear of the module. When the module is mounted, these metal plates are in contact with the metallic support plate. Shielded connectors (RJ45 Ethernet, SubD9 Profibus) are also connected to FE.

To avoid an electric shock caused by indirect contact, FE must be connected to the protective ground.

DANGER

ELECTRIC SHOCK HAZARD

Connect the Field Earth terminal to the Protective Earth (PE) before connecting the Ethernet and Profibus shielded cables.

When you remove the connections, disconnect the ground wire last.

Always use suitable insulation equipment for these operations.

Failure to follow these instructions may result in serious injury or death.

3.7 Profibus Connection

SST-PB3-REM Profibus Connector

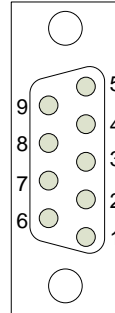

No.	Signal
1	Earth
2	Not connected
3	PFB B
4	RTS
5	PFB 0Vdc
6	PFB 5Vdc
7	Not connected
8	PFB A
9	Not connected

Profibus cabling

The following references should be used for connectors:



Part Number	SAP Number	Description
MA9D00-42	120100-0005	0° D-Sub, 9-pin, male connector, integrated terminator, with diagnostics LEDs.
PA9D0B-42	120103-0003	45° D-Sub, 9-pin, male connector, integrated terminator, with diagnostics LEDs.
PA9D01-42	120103-0001	90° D-Sub, 9-pin, male connector, integrated terminator, with diagnostics LEDs.
PA9S01-42	120103-0005	90° D-Sub, 9-pin, male connector, integrated terminator.
PBSTRIP	120103-0007	Cable stripping tool.

3.8 Ethernet Connection

RJ45 Ethernet Connector

Illustration of the RJ45 shielded connector for the Ethernet link:

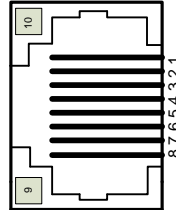

No.	Signal
1	Tx+
2	Tx-
3	Rx+
4	Not connected
5	Not connected
6	Rx-
7	Not connected
8	Not connected
9	Link/Activity LED
10	Link Status LED

Ethernet Cables

Category 5 Shielded Twisted Pair (STP) with RJ45 connectors conforming to TIA-EIA-568A.

3.9 Power Supply

Description

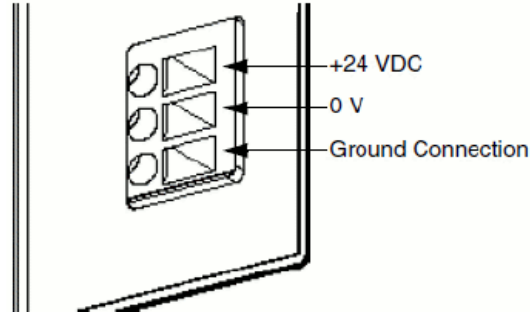

Leg	Description
+24 VDC	24 Volt DC input terminal.
0 V	0 Volt input terminal.
Ground Connection	Field Earth - grounded terminal connected to the SST-PB3-REM chassis.

The SST-PB3-REM module must be powered by an external 24VDC industrial power supply unit which must be compliant with the characteristics in section 4.10, Electrical Characteristics.

The power supply must be local: cable length < 30 m.

An external fast-acting fuse must be used.

The SST-PB3-REM module is protected against reverse wiring.

⚠ CAUTION

IMPROPER FUSE SELECTION

Use fast-acting fuses to protect the electronic components of the module from over-current and reverse polarity of the supply. Improper fuse selection could result in damage to the module.

Failure to follow these instructions may result in injury or equipment damage.

Power cord preparation

Wherever possible, use wires that are 0.2 to 2.5 mm (24 - 12 AWG) for the power cord, and twist the wire ends before attaching the terminals.

- Solid or stranded wire may be used.
- For stranded wire, improperly twisting the wire ends may cause short loops. To avoid this, use DZ5CE/AZ5CE cable ends.



Stripping length

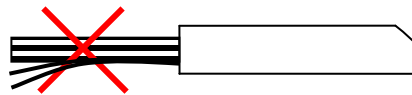
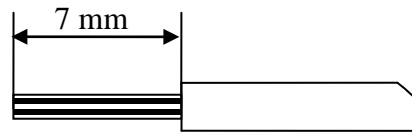

Twisted wire

Connecting the Power Cord

Proceed as follows:

- Ensure that the power supply module is **POWERED OFF**.
- Insert the wire end in the corresponding hole of the power connector and tighten it by using a flat blade screwdriver (size 0.6 x 3.5 mm).

Set Power ON

Power-up the power supply module.

The SST-PB3-REM module LEDs will light up to indicate that the power is on and the module is booting (approximately 30 s).

3.10 Electrical Characteristics

Parameter	Minimum	Nominal	Maximum
Supply Voltage	18 VDC	24 VDC	30VDC
Ripple Factor (Vp-p)			10%
Permissible overvoltage (for 1 hour out of 24 hours)			34 VDC
Current Consumption		150 mA @24VDC	200mA @24VDC
Power Loss		3.6W	4.8W
Length of power outage in the absence of power supply	10 ms		

3.11 Hardware Standards

Compliance with Standards

Item	Complied Regulatory Standards
Automation products standard	IEC61131-2
CSA Requirements	CSA22.2 No. 142
CSA certification for Hazardous Locations	CSA 22.2 No.213 Class I Division 2 Groups ABCD
UL Requirements	UL508
Merchant Navy agencies certifications	IACS E10
CE Marking - Conformity to European Directives : <ol style="list-style-type: none"> 1. EMC Directive No 2004/108/EC 2. LV Directive No 2006/95/EC 	

 **DANGER**

EXPLOSION HAZARD

This equipment is suitable for use in hazardous locations Class 1, Division 2, Groups A, B, C and D only or non-hazardous locations. Do not disconnect unless power has been switched off or the area is known to be non-hazardous.

Failure to follow these instructions may result in serious injury or death.

3.12 Condition of Use

Applicable Conditions

Operating conditions :

- Temperature : 0°C to 70°C
- Relative humidity : 10-95% (non-condensing)
- Cooling : Convection, No fan
- Altitude : 2,000 m (Operational)
- Vibration resistance :
 - 2G sinusoidal with plate or Premium rack mounting
 - 1G sinusoidal with DIN rail mounting

Storage conditions :

- Temperature : -40°C to 85°C
- Relative humidity : 10-95% (non-condensing)

4

Software Features

Chapter Sections:

- Introduction
- Configuring SST-PB3-REM as a DP-V0 Master
- Online Browsing with DP View
- Downloading Configuration
- Exported L5X File Contents
- Master Status
- Commands
- Connecting to Configured Master
- Diagnosing Slave Errors

4.1 Introduction

The SST™ Profibus Configuration Tool is the software application used for configuring the Profibus DP-V0 Master functionality of SST-PB3-REM. In addition to configuration, several other features such as retrieving diagnostics information, downloading firmware, etc. will be discussed later in this chapter.

To launch the application:

1. Click the Windows  button.
2. Click on Programs > BradCommunications > SST Profibus > SST Profibus Configuration Tool option.

The SST™ Profibus Configuration Tool consists of a main or Network view and two panes: the Profibus Devices pane (Device Library) and the Online Browse pane (DP View) (see Figure 5.1-1 below).

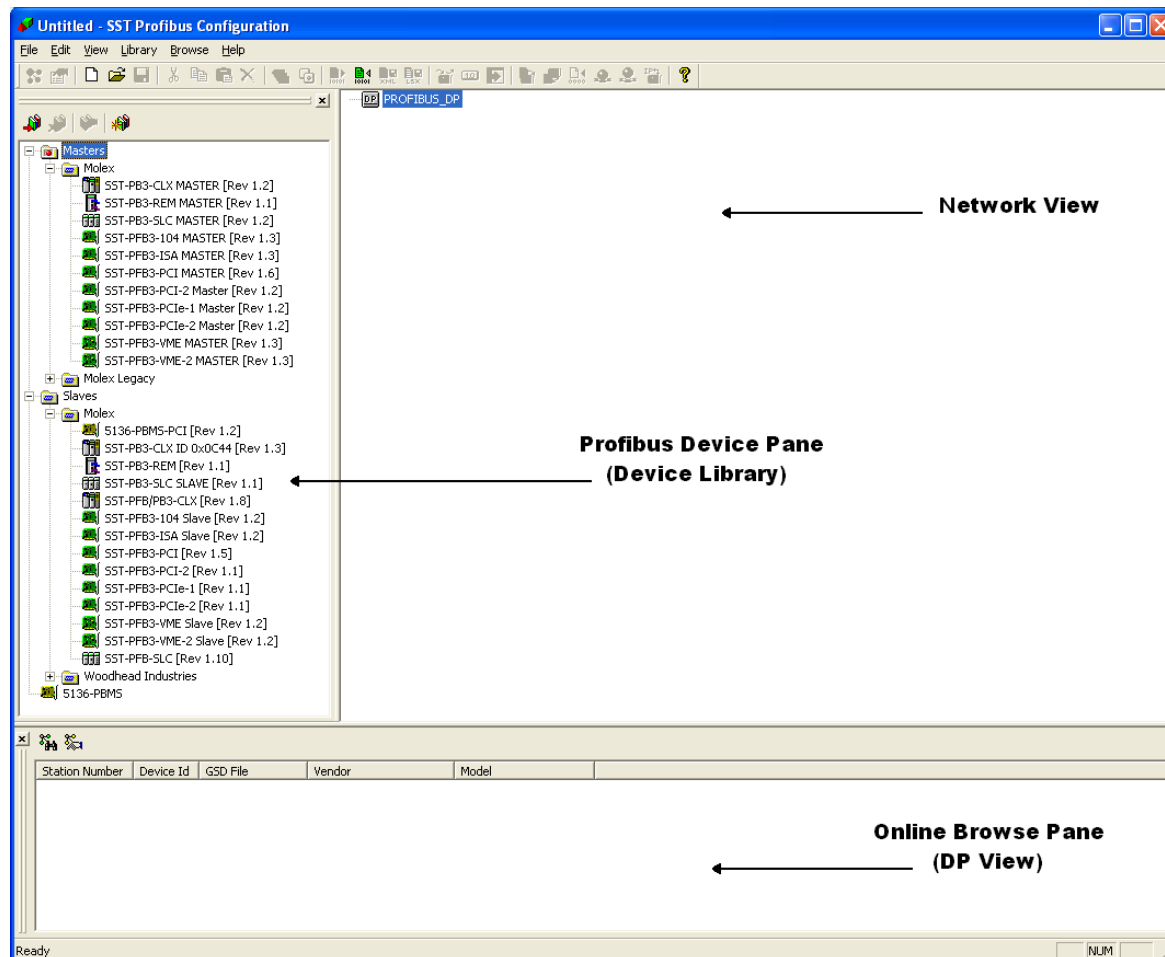

Figure 4.1-1: SST™ Profibus Configuration Tool

The Device Library contains all of the supported Profibus masters (SST™ only) and slave devices. By default, only SST™ slaves are present in the library. More devices may be added as needed using the Add GSD feature under the Library tab.

This pane appears by default in the upper left-hand side of the main window. To close/open the Device Library pane, select View > Library.

The Network view is where the master configuration is created. Drag and drop any master to start a network. Slaves may be dragged and dropped under any master in the view.

DP View is used to detect any slave devices that are active on the Profibus network.

This pane appears by default at the bottom of the main window. To close/open the DP View pane, select View > Online.

4.2 Configuring SST-PB3-REM as a DP-V0 Master

This section describes how to set up a typical master using the SST Profibus Configuration Tool.

After the configuration is created, it must be downloaded to module's flash memory. The module will use this configuration every time it becomes active on the Profibus network without needing to be reconfigured.

1. Launch SST™ Profibus Configuration Tool.
2. Select File > New to create a new configuration.
3. Select the SST-PB3-REM Master device in the Device Library.

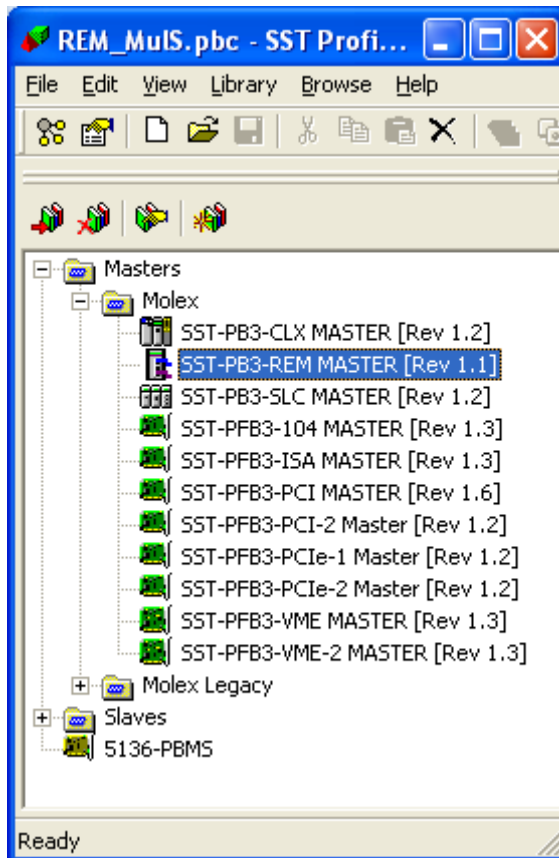

To add this Master device to the Network view:

- Drag and drop it into the Network view.

OR:

- Click on the Add to Network  icon on the main toolbar. The master configuration window displays at the Communication Path page. For details on configuring the Communication Path, see section 4.2.1, Communication Path Configuration.

4. A Remote Module I/O Mapping pop-up window will be displayed asking to select 1 of 2 methods to use for the I/O mapping.

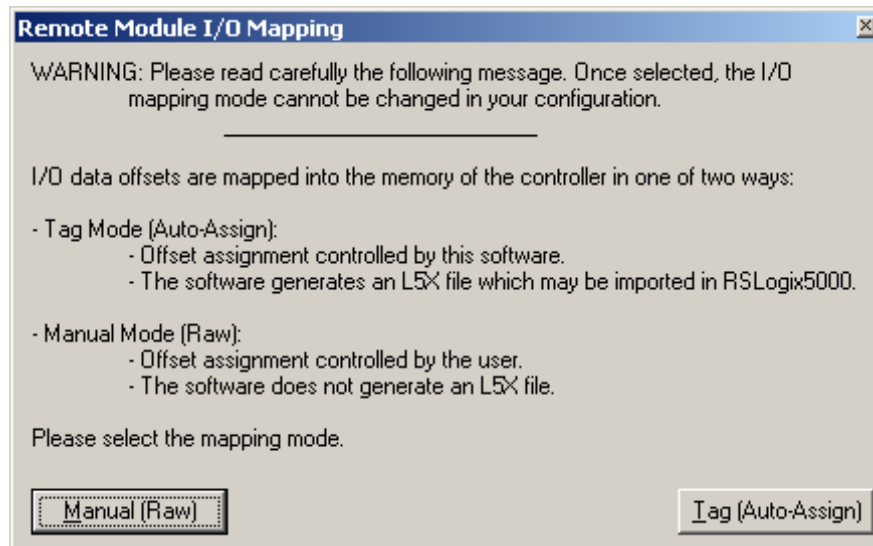

5. Select **Manual Mode** (Raw) to control the I/O offset assignment and a L5X File containing I/O tags is not a requirement for your RSLogix5000 Project. Select **Tag Mode** (Auto-Assign) if an L5X file containing I/O tags is needed and no control of I/O offset assignment is needed.
6. Select General tab and select the station number in the Station field. The master name may also be changed under Name: it may not exceed 20 characters, may contain letters, numbers and/or single underscores, must start with a letter or underscore and must not end with an underscore.

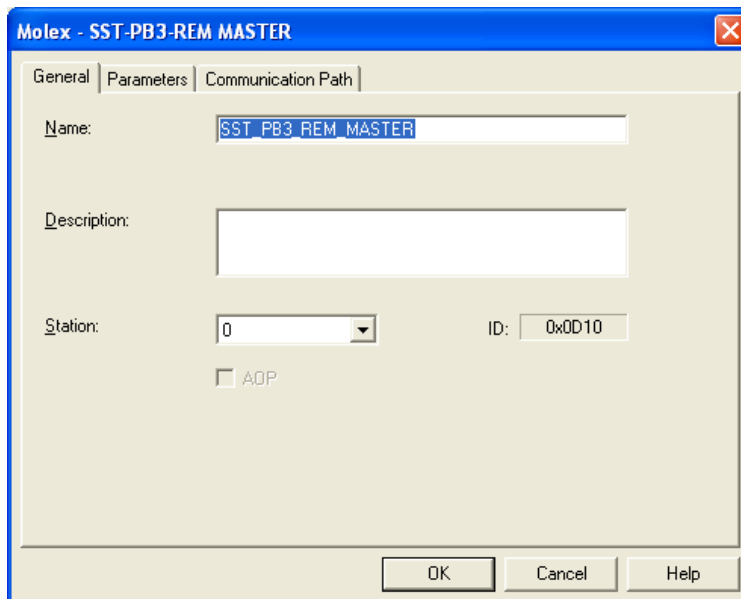

7. Select the Parameters tab and configure as detailed in [section 4.2.2](#).

- Click OK to save the settings. The Master device is added to the Network view



Note

To edit master properties, right-click on the master name and choose Properties from the shortcut menu or select the device from the Network view and select the Properties icon  on the main toolbar.

- Find and select the desired slave device from the Device library. If the slave device is not listed:

- Click on the Add Device icon  in the Device library to add the GSD file for the desired device. The Add Profibus Devices window opens.

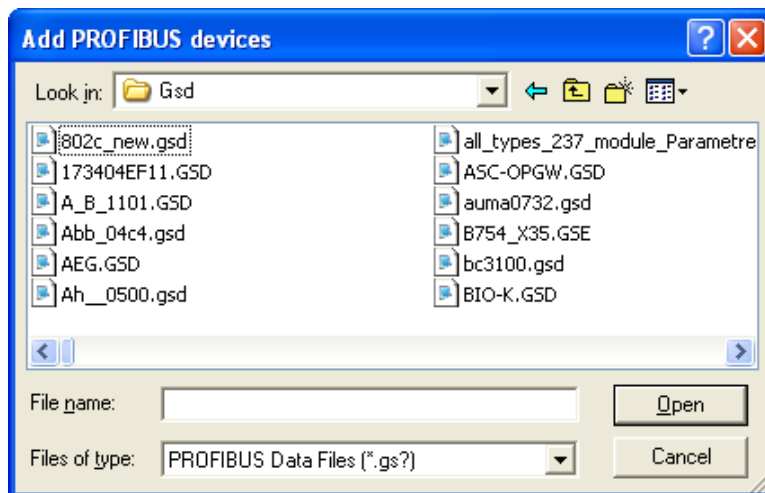

- Locate the GSD file and click Open.



Note

A GS* file should have been supplied with the slave device. If not, contact the vendor or search for it on the Internet at:

<http://www.Profibus.com/products/gsd-files/>

* signifies the language

The GSD file is added to the Device library (left-most pane).

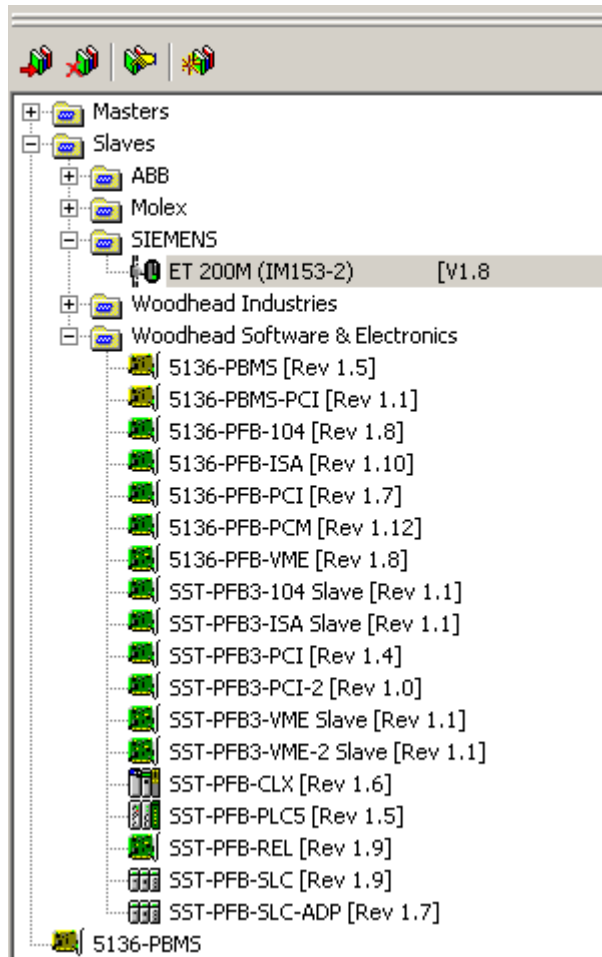

10. Devices can now be added to the Network view by manually inserting each slave from the device library or by using the Online Browse feature, see section 5.3, Online Browsing with DP View for details.
11. Drag and drop a slave onto the network view under the master device.
12. Click on the Add to Network icon  on the main toolbar to display a configuration window for the selected slave. By default, this window displays the General tab.

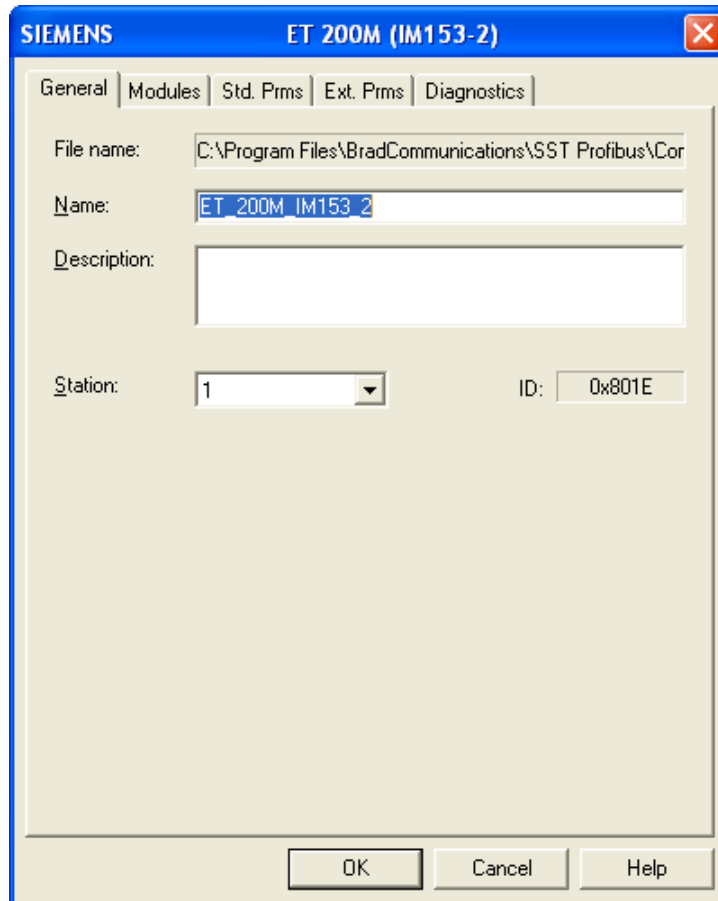

13. Set the station address of the slave in the Station field.
14. Select the Modules tab.

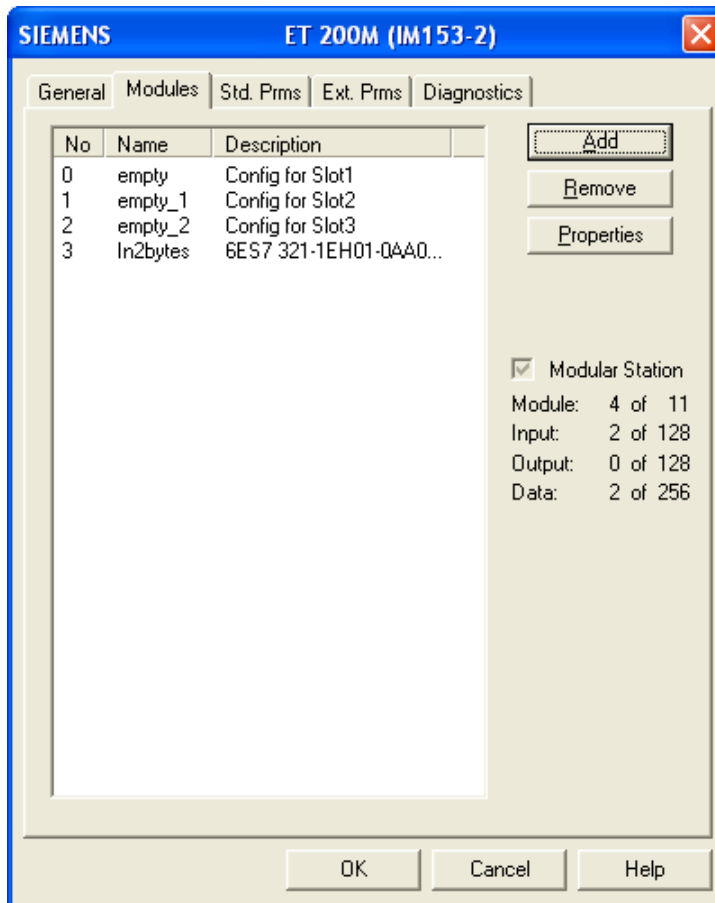

If the slave is modular, insert the modules that the slave device uses. To do this, select the Add button to display the Add Modules window.

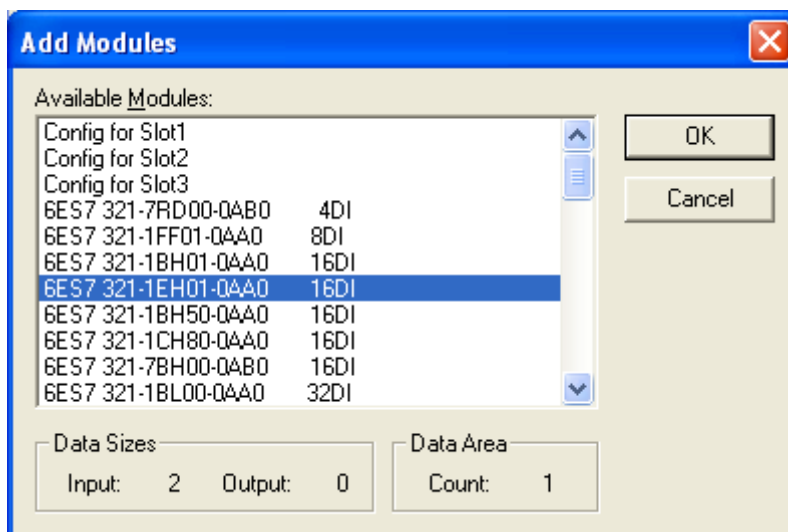

If the slave is not modular (compact device), the modules have already been configured.

15. After selecting the I/O module click on the Properties button to start editing the data area properties: defining variables and setting extended parameters (if they exist) see section

4.2.3, Device Data Area Configuration for details.

16. Select the Std. Prms tab and configure as detailed in section [4.2.5](#) , Device Standard Parameters Configuration.

17. Select the Ext. Prms tab (if it exists).

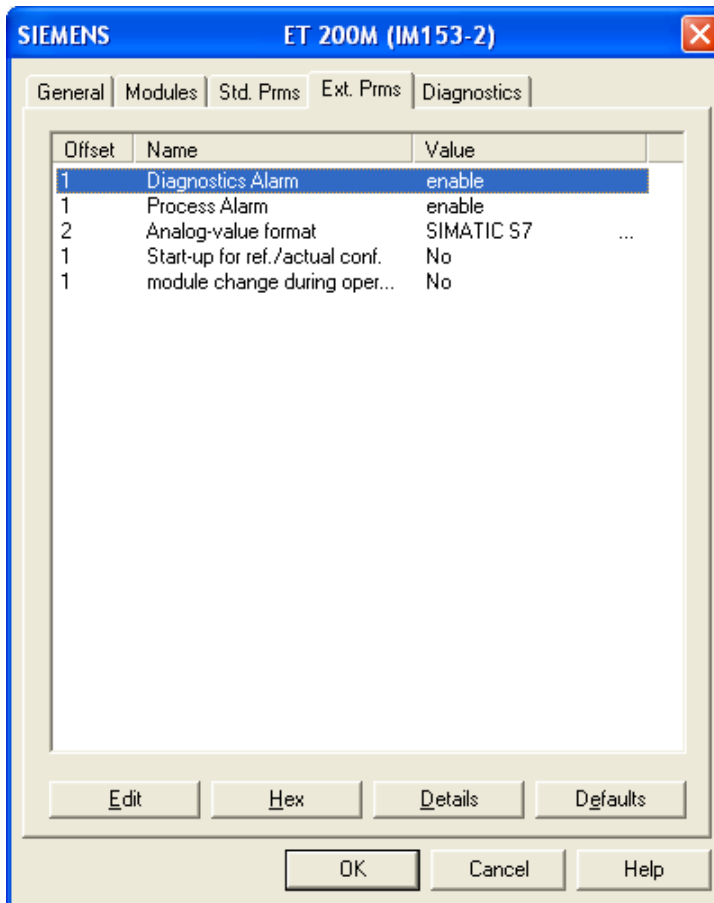

- The definitions of the various buttons are below:
 - **Edit** - Allows parameters to be changed. Parameters can also be edited by double-clicking.
 - **Hex** - Displays parameters data in hexadecimal format.
 - **Details** - Displays parameter characteristics.
 - **Offset** - Parameter byte offset. First parameter starts at offset 0.
 - **Name** - Parameter name.
 - **Value** - Displays as text (where available) or a numeric value.

The Ext. Prms page is added to the device configuration only if the ExtUserPrmData is present in the slave GSD file.

To edit a parameter, select parameter to change and click on **Edit** button to change the parameter value.

18. Select the DP-V1 tab (if it exists) and configure as detailed in section [4.2.7](#), Device DP-V1 Configuration.
19. If using Tag (Auto-Assign) I/O Mapping mode for Master, proceed to step 22. If using Manual (raw) I/O mapping mode, select the Address tab. The Address tab will not be displayed if Tag (Auto-Assign) mode was selected for Master.

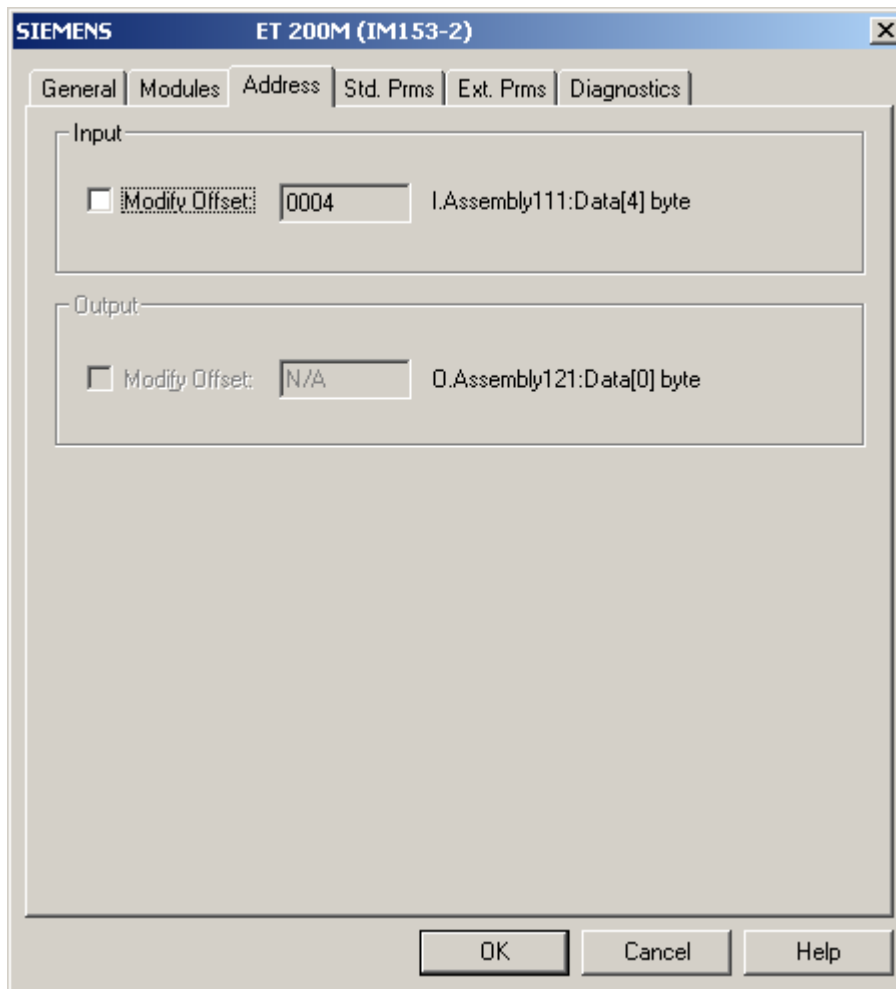

20. Assign input and/or output addresses. In this example an input address is only assigned. Offsets begin at offset 4 for the first CIP connection 1. A slave data area will never be split between 2 CIP connections. For example, if a new slave is added to a configuration that has almost used all space in CIP connection 1, the while slave data area is moved to CIP connection 2.

21. Select OK.

22. Repeat steps 10-21 for each slave device on the network.
23. To set the parameters for the network, right-click on the highest level of the Network view (default is Profibus_DP) and choose Properties from the shortcut menu. The Network window will now be displayed, allowing the Baud Rate and other parameters to be set. To edit Timing and other miscellaneous parameters choose either the Timing or Parameters tabs.

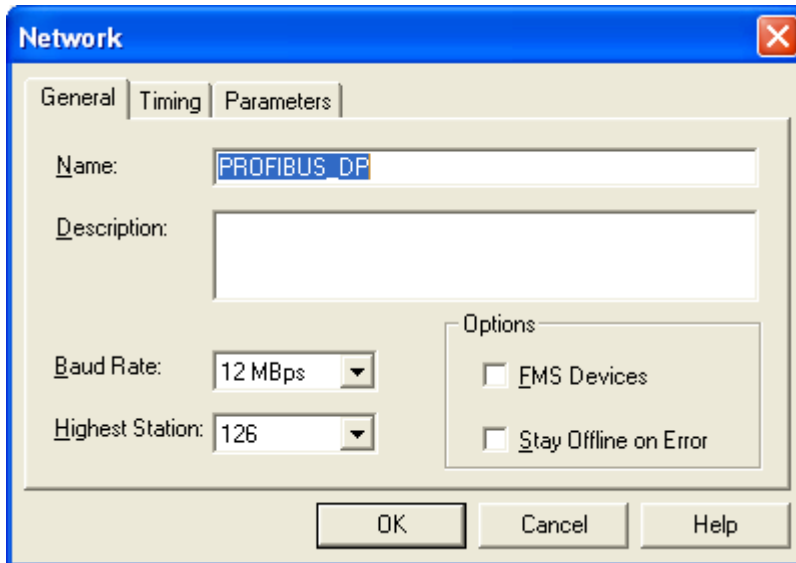

24. Configure the following parameters according to the Profibus network.
 - **Name** - Name of the network.
 - **Description** - Description of the network.
 - **Baud Rate** - Baud rate of the Profibus network.
 - **Highest Station** - Highest allowed station address for any active station on the network. The highest station affects how much time is spent soliciting for new nodes.
 - **Options** - These affect the network parameters that the Configuration Tool assigns:
 - **FMS Devices** - indicates whether or not there are any FMS devices on the network.
 - **Stay Offline on Error** - indicates whether or not the SST-PB3-REM stays offline when Token Error Limit or Response Error Limit is exceeded within 256 token cycles.
25. Once the parameters have been set, select OK to save the new settings.
26. To save the configuration file select File>Save or Save As.
27. Specify a filename and location for the configuration and select Save. This will save the project as a .pbc file.

Click on List Identity to display all SST-PB3-REM modules present on the network, with their corresponding IP and MAC addresses. To select a module, double click on it, the Browse For Devices window will automatically close and the IP address of the selected module will be set in the Communication Path page.



Note

For large networks, if List Identity is unable to detect the SST-PB3-REM module(s), the Time-out value, which defaults to 1 second, may be increased to up to 20 seconds.

If the factory default IP Address is desired, select the Use Static IP Address button.

4. A CIP path may also be configured in cases where the Remote Module is not directly accessible on the same physical network with the local interface card.

Before editing the path, the First Bridge IP Address must be entered.



Note

The EtherNet/IP bridge must be on the same physical network as the local network interface card.

Click on Edit Path... to launch the CIP path editor.

Mod	Port	Link 1	Mod	Port	Link 2

Expert Mode

CIP Path (Symbolic):

CIP Path:

The path may be edited in two modes:

- Regular – the configuration tool will automatically create the path with minimal input from the user.
- Expert –the user enters the path without application assistance. The format of the path is hexadecimal numbers separated by spaces.

When editing the path in regular mode the following should be considered:

- To add a new segment to the path, click Add. Remove Last Segment removes only the last segment from the path.
- The first segment in the path must be PC – ENBT. Link1 is automatically set to the IP address of the first EtherNet/IP bridge, Link2 should be set to the slot number of the next EtherNet/IP bridge in the path. This segment may not appear elsewhere in the path.
- The last segment in the path must be ENBT – PB3-REM. This segment may not appear elsewhere in the path.
- As the path is being edited, it is displayed under CIP Path (Symbolic) as well as under CIP Path. In Expert mode, the path format should appear as displayed in CIP Path.

The Cancel button will close the path editor without saving the path.

The OK button will save the path and close the dialog box. The new path will be displayed in the Communication Path page, under CIP Path.

4.2.2 Master Parameters Configuration

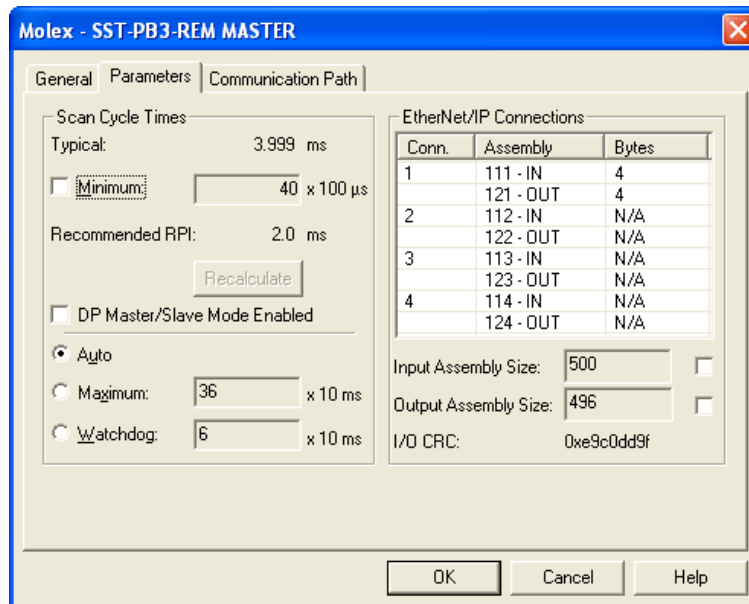

Typical Scan Cycle time will be calculated automatically according to the baud rate, and number of slaves. Minimum Scan Cycle time is calculated as maximum between Typical Scan Time and the highest minimum slave interval of all slaves (from the GSD file).

Recommended RPI is calculated as half the Minimum Scan Cycle. This guarantees that all input data read from Profibus will be sent on the EtherNet/IP network.

Note that this is only a recommendation, choosing the right RPI will ultimately depend on the specific application requirements.

1. If the network baud rate is 12M and Master/Slave mode is enabled on the SST-PB3-REM module, the corresponding checkbox on this page must be checked. The Typical and Minimum Scan Cycles as well as the recommended RPI are increased by 2ms.



Note

It is recommended to leave all Scan Cycle Time values at their defaults (Minimum checkbox, not checked, Auto radio button, selected).

If the user chooses to modify the Minimum Scan Cycle, Minimum checkbox checked, the recommended RPI Recalculate button becomes enabled and may be used to recalculate the RPI based on the new Minimum Scan Cycle.

2. By default the Input Assembly Size is set to 500 bytes; this corresponds to the size configured in RSLogix5000. To modify the value, the adjacent checkbox must be checked and a value between 4 and 500 may be entered. This is only allowed when starting the profibus configuration with only the Profibus Master existing. Once slaves are added to the configuration the Input Assembly Size can no longer be modified.
3. By default the Output Assembly Size is set to 496 bytes, this corresponds to the size configured in RSLogix5000. To modify the value, the adjacent checkbox must be checked and a value between 4 and 496 may be entered. This is only allowed when starting the profibus configuration with only the Profibus Master existing. Once slaves are added to the configuration the Output Assembly Size can no longer be modified.



Note

The first four bytes of input assembly 111 and output assembly 121 are reserved for Command Reply and Control registers.

It is recommended to leave the assembly sizes at their default size. They should be changed only if the application uses devices on the EtherNet/IP network that do not support the default data sizes.

The data from all 4 input and output assemblies is mapped into the SST-PB3-REM UDT included in the L5X file provided by the configuration tool, that may be imported into RSLogix5000.

4. I/O CRC is a calculated value that may be used from the controller side to ensure the Remote Module is configured with the correct Profibus configuration:
 - Last 4 bytes of the Configuration parameter of the first Exclusive Owner connection may be set to this value. Upon establishing the connection between the

EtherNet/IP scanner and SST-PB3-REM, if the Remote Module detects that this CRC does not match the one calculated on the configuration existing in its flash, the connection is rejected. If the last 4 bytes are left at 0, the I/O CRC check is not performed.

- The ladder code may also use this value to validate the UDT.

4.2.3 Device Data Area Configuration

4.2.3.1 When using Tag (Auto-Assign) I/O mapping mode

Detailed information about all variable types within a module for a slave is provided, regardless of how the module is defined, using special identifiers or a standard definition of one byte. Only standard variable types will be supported. If the configuration tool encounters manufacturer specific types, it will default to an array of bytes or words, depending on the format of the length bytes.

1. Select the Input Variables tab (in this example only the Input Variables tab is populated since this is an Input-only module).

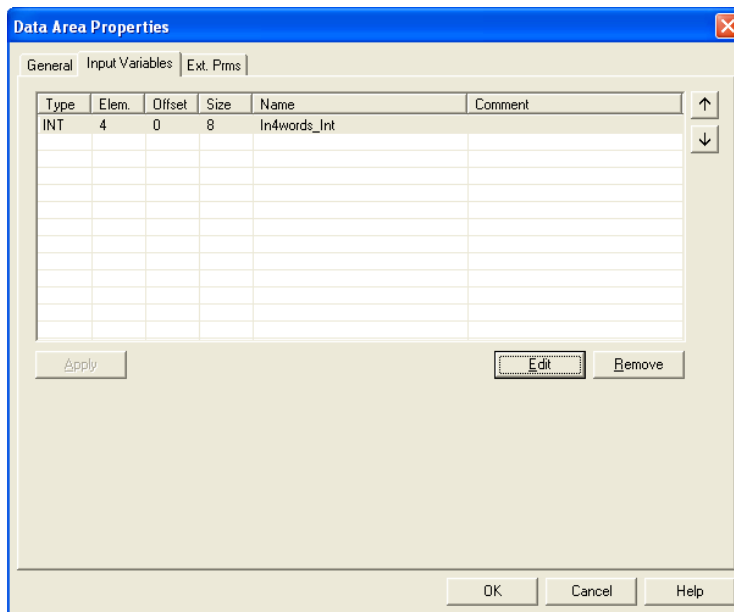

2. Select the first variable and click Edit, to open the variable editor:

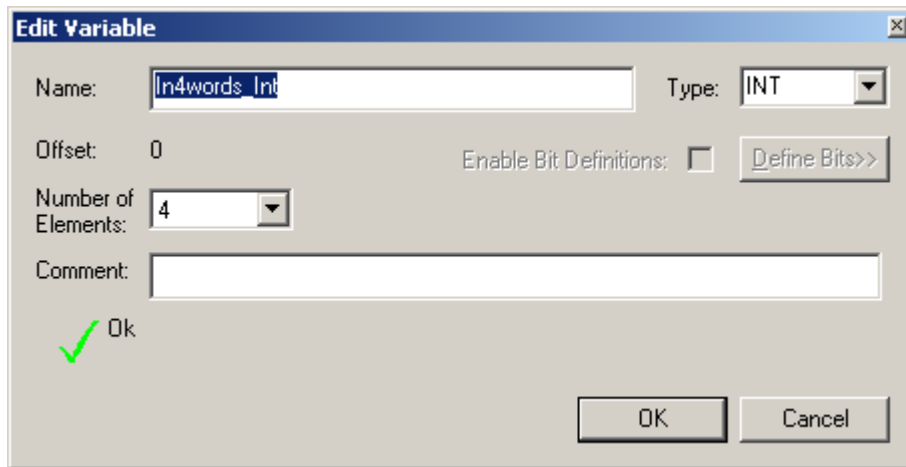

The screenshot shows the 'Edit Variable' dialog box with the following settings:

- Name: ln4words_Int
- Type: INT
- Offset: 0
- Number of Elements: 4
- Comment: (empty)
- Enable Bit Definitions: Define Bits>>
- Buttons: OK, Cancel
- Indicator: A green checkmark is visible next to the 'Ok' label.

The variable editor allows the user to define variables with names and types relevant for specific applications. These variables are part of the UDT generated by the configuration tool which may be imported in RSLogix5000 in L5X format.

The editor is designed to be compatible with RSLogix5000, meaning the variable names are expected to follow the tag names conventions. The variable types correspond to RSLogix5000 atomic data types: SINT, INT, DINT and REAL.

The number of elements is always relative to the data type. In the example above the variable size is 4 words, which translates into 4 INT elements.

One of the consequences of changing the data type may be the creation of additional variables. In the example above if we change the type to SINT and the number of elements to 1, the configuration tool will automatically create another variable FREE_0 of type FREE (reserved type for FREE_x variables, translates to SINT for the UDT) to ensure the overall size for the data area remains unchanged:

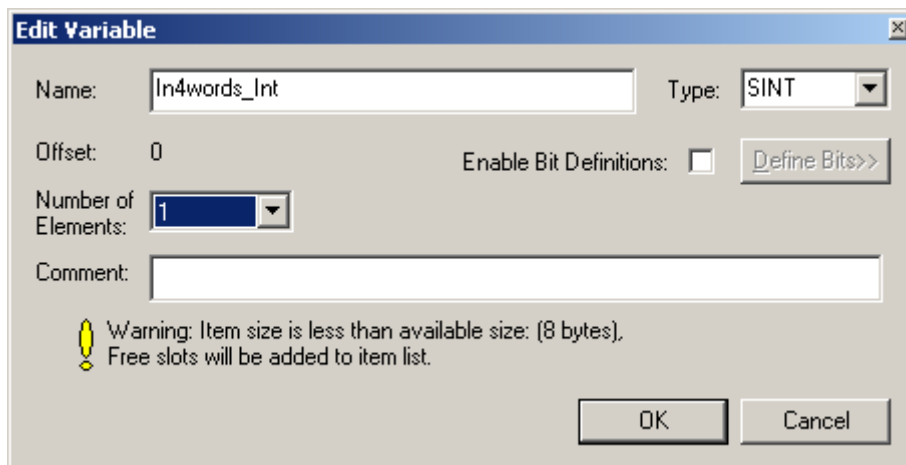

The screenshot shows the 'Edit Variable' dialog box with the following settings:

- Name: ln4words_Int
- Type: SINT
- Offset: 0
- Number of Elements: 1
- Comment: (empty)
- Enable Bit Definitions: Define Bits>>
- Buttons: OK, Cancel
- Warning: A yellow warning icon is present with the text: "Warning: Item size is less than available size: (8 bytes). Free slots will be added to item list."

3. Click ok.

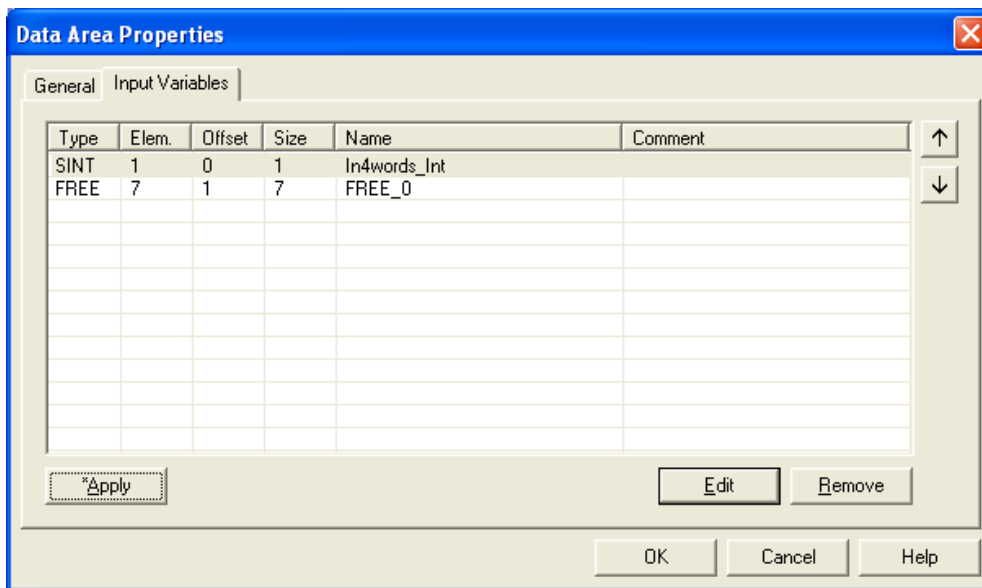

For single variables of type SINT (number of elements, 1), the editor provides a bit definition feature. Checking the Enable Bit Definitions: checkbox enables the Define Bits button which may be clicked to define individual bits. Note that once the feature is activated, the configuration tool provides default names for the bits. If the checkbox is unchecked the bit definitions are removed.

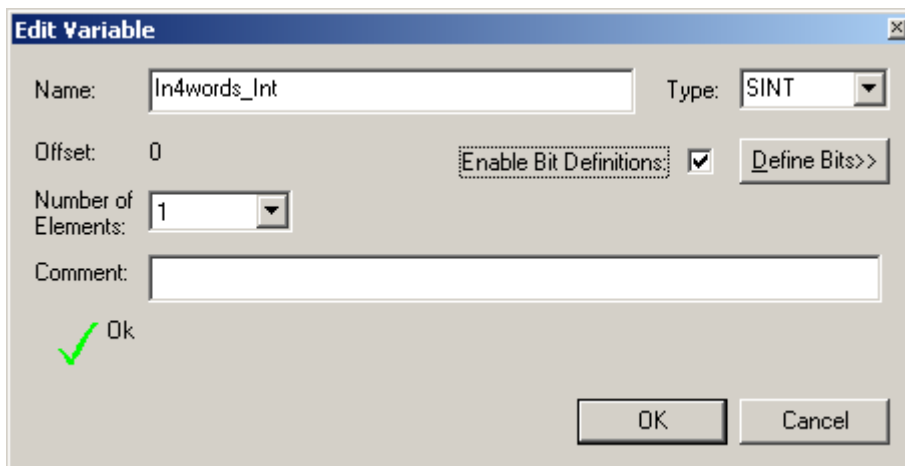

Selecting “**Enable Bit Definitions**” and selecting **Define Bits>>** displays the following tags for each bit.

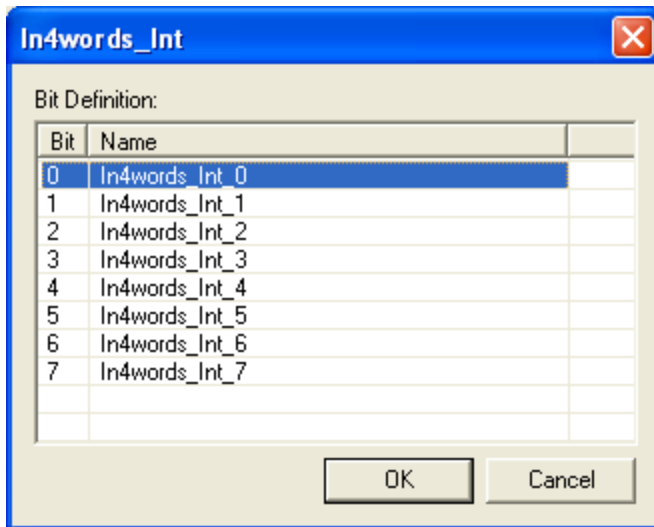

The “up” and “down” arrows, situated on the right hand of the dialog box, allow changing the mapping order of the variables in the I/O assemblies.

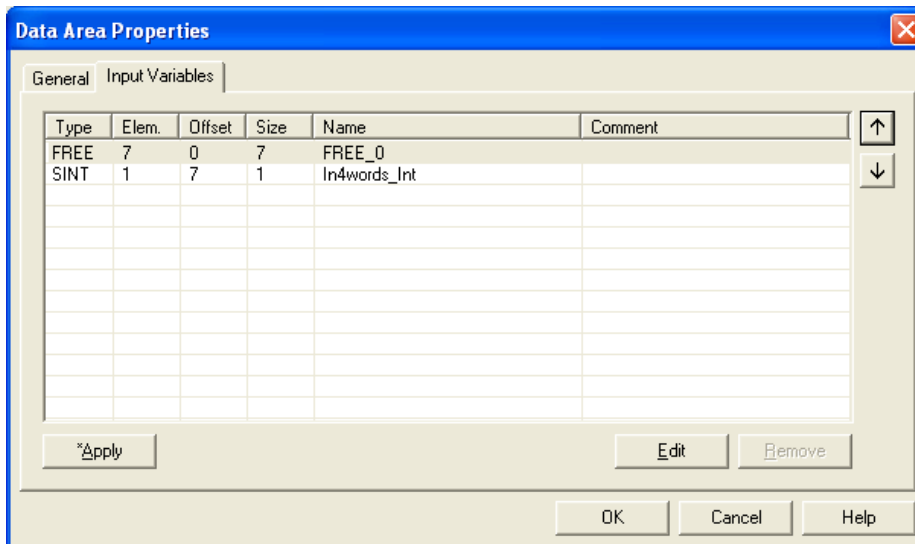

4. Ext.Prms Tab (if it exists) allows setting extended parameters according to the device.

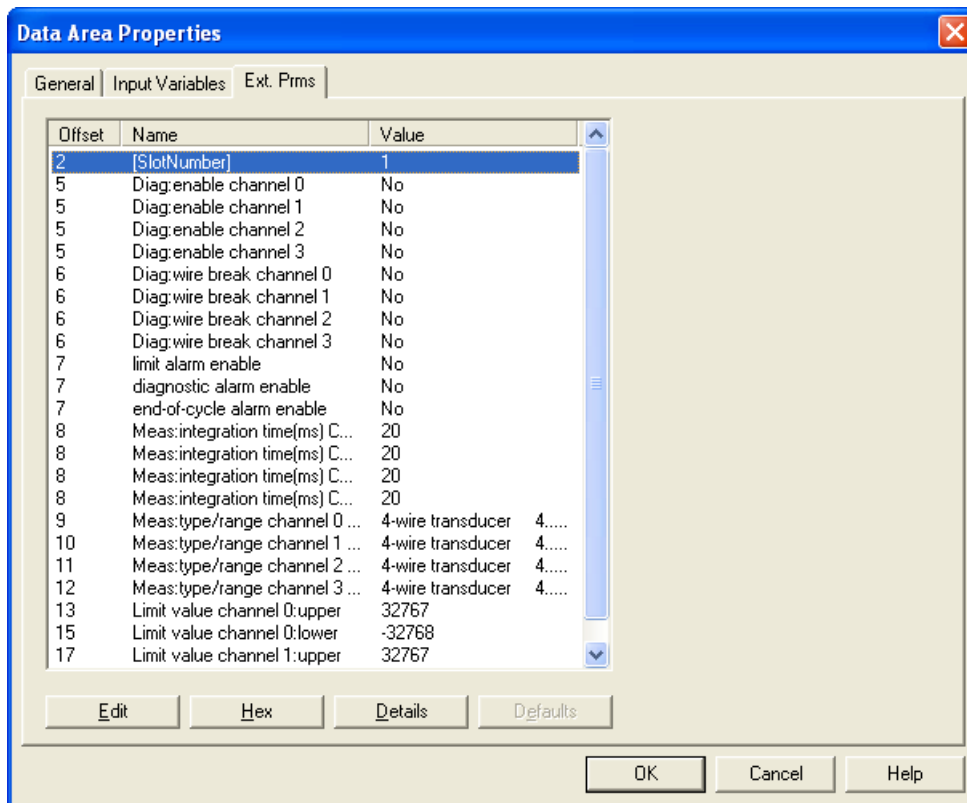

4.2.4 When using raw mode (manually assign) for the REM I/O mapping mode)

When using Manual mode for mapping the Profibus masters I/O, custom offsets can be used for I/O. If the I/O assembly sizes need to be reduced from the default size (500 bytes Inputs, 496 bytes Outputs, 500 bytes Status) make the modifications necessary before adding slaves to your Profibus configuration.

A slave's data area will never be allowed to split between two CIP connections. If leaving gaps between slaves for future I/O expansion keep in mind that when adding new slaves the next available I/O offsets assigned will be the space available starting from the 1st CIP connection. No L5X mapping file will be automatically generated like in tag mode.

4.2.5 Device Standard Parameters Configuration

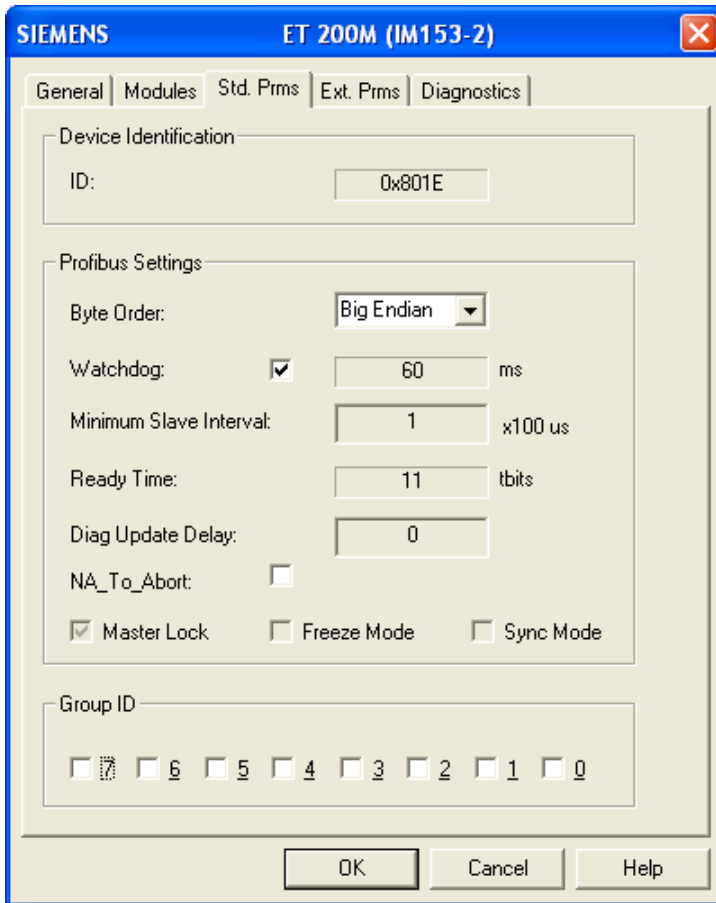

- ID: the Profibus identification number for the slave.
- Byte Order: the order that the data is presented in RSLogix 5000. Big Endian is the default setting.
- Watchdog: the maximum length of time, before the device times out if it is not scanned by its master.
- Minimum Slave Interval: this is the minimum length of time between two I/O scans of this device.
- Ready Time: the time within which a master station shall be ready to receive an acknowledgement or response after transmitting a request.
- Diag Update Delay, see Profibus Specification for details.
- NA_To_Abort: abort if no answer. If checked, at the end of a boot up sequence (DIAG1, SETPARAM, CHECKCONFIG, DIAG2 then DATA EXCHANGE) if the device does not answer in DIAG2 or DATAEXCH state, after the numbers of retries defined in the configuration, the module returns to DIAG1 state. If unchecked, the module stays in DIAG2 or DATAEXCH state.
- Master Lock: Enabled by default. When set, another master cannot take control of this device being scanned by the active master.
- Freeze Mode: Is used to control when input data is read from device. Input data from device

is frozen on master until the next freeze command is sent to device.

- Sync Mode: Is used to control when output data is updated on device. Output data to device is frozen until the next sync command is sent to device.
- Group ID: See Profibus Specification for details.

4.2.6 Device Extended Parameters Configuration

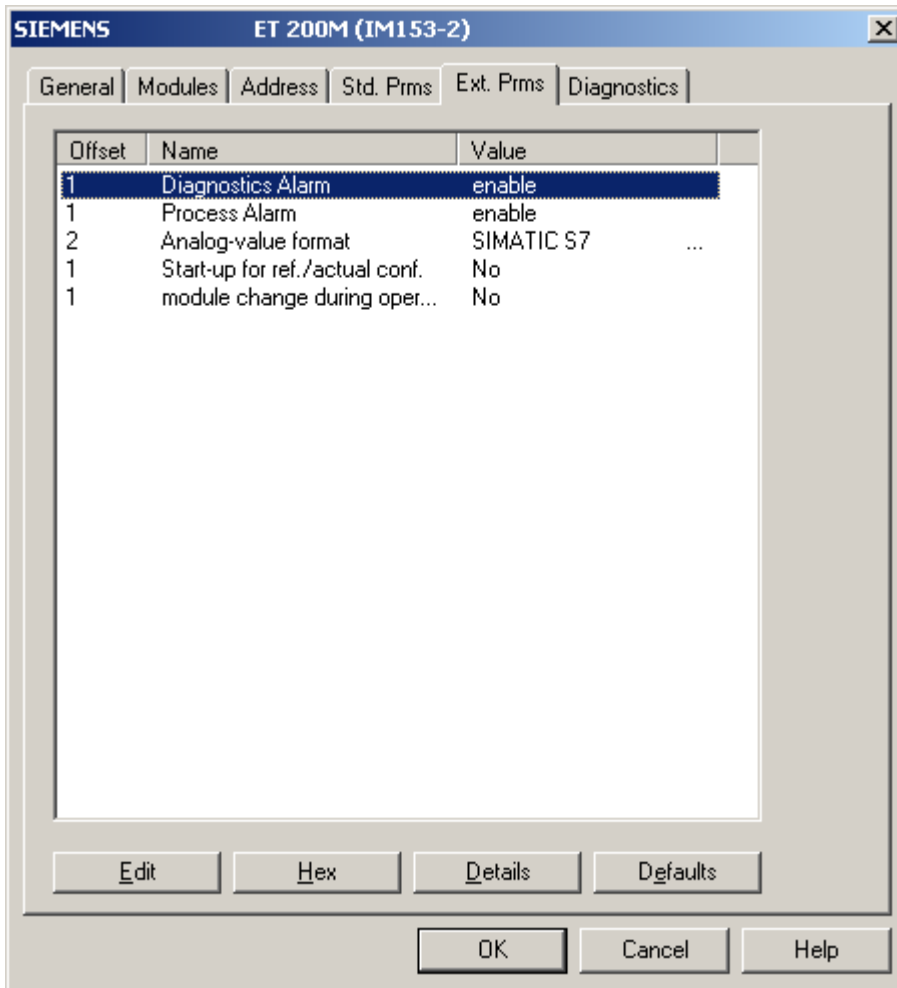

The Ext. Prms page is added to the device configuration only if the ExtUserPrmData is present in the slave GSD file.

To edit a parameter, select parameter to change and click on **Edit** button to change the parameter value.

Clicking on **Hex** button displays the extended parameter in Hex notation.

Clicking on **Details** button displays more information on the parameter highlighted.

Selecting the **Defaults** button sets all the parameters back to their default values.

4.2.7 Device DP-V1 Configuration

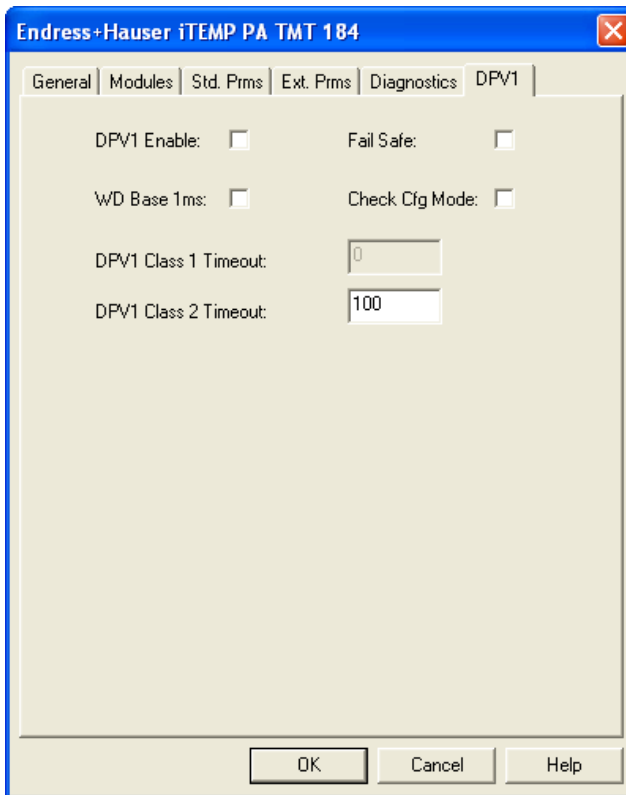

The DP-V1 page is added to the device configuration only if the DPV1_Slave key in the GSD file is set to 1.

The checkboxes on this page correspond to the bits with the same name contained in the DPV1_Status bytes (see Profibus DP-V1 specification for details). They are initialized to the values read from the GSD file.

Note that the state of the checkboxes does not imply the bits will also be set accordingly in the user parameter data. This must be indicated explicitly by clicking OK once the page is viewed or upon leaving the page, by responding Yes when inquired about applying the DP-V1 settings.

The checkboxes are checked if the corresponding bit of Ext_User_Prm_Data_Const(0) is set, or:

- DP-V1 Enable is checked if C1_Read_Write_Supp key is set to 1.
- WD Base 1ms is checked if WD_Base_1ms_Supp key is set to 1.
- Check Cfg Mode is checked if Check_Cfg_Mode key is set to 1.



Note

If the WD Base 1ms checkbox is checked and the user chooses to set this DP-V1 status bit, then at 93.75 and 45.45 Kbaud the watchdog value in the Std. Prms page may have to be manually increased to avoid slave timeouts on the Profibus network.

The Fail Safe checkbox is dependent on a combination of two keys, Fail_Safe and Fail_Safe_required. Its behavior is described in the table below:

Checkbox State	Fail_Safe GSD Key	Fail_Safe_required or Corresponding Bit of Ext_User_Prm_Data_Const(0)
Enabled and Checked	1	0 / Not present
Enabled and Unchecked	0 / Not present	0 / Not present
Disabled and Unchecked	0 / Not present	1
Disabled and Checked	1	1

4.3 Online Browsing with DP View

DP View allows the PB3-REM master to search a Profibus network for any slaves present on the network. To start a search see the steps below.

1. Verify that the controller is in Program or Off mode.
2. Select the Network Search Properties  icon. The DP View window will appear as shown below:

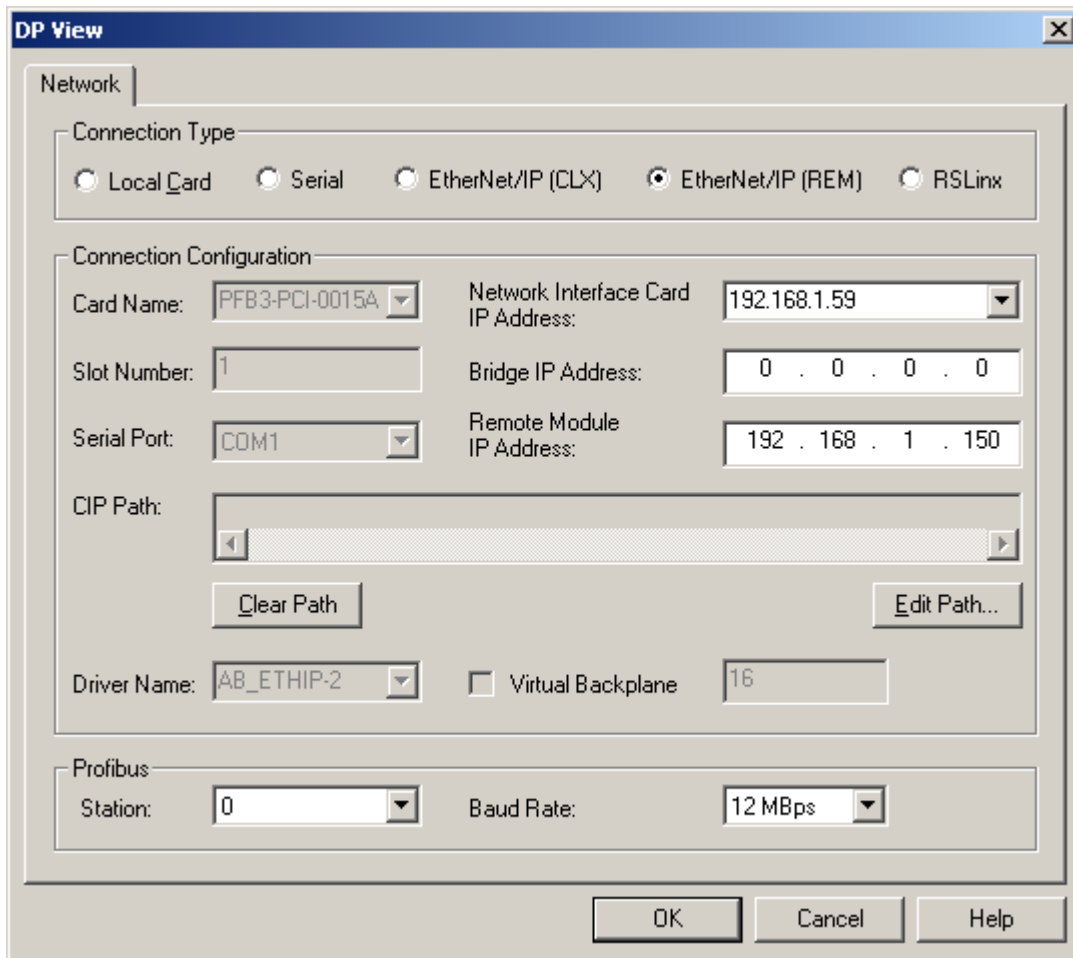

3. Select EtherNet/IP (REM) in Connection Type and configure the communication path as detailed in section 5.2.1, Communication Path Configuration.
4. Set Station to a unique station number, one not used by any of the slaves on the network.
5. Set Baud Rate to the baud rate of the Profibus network.
6. Select OK to save the settings.
7. Select the Search for Slave  icon when ready to browse. Slaves that have been detected are displayed in station address order, as shown:

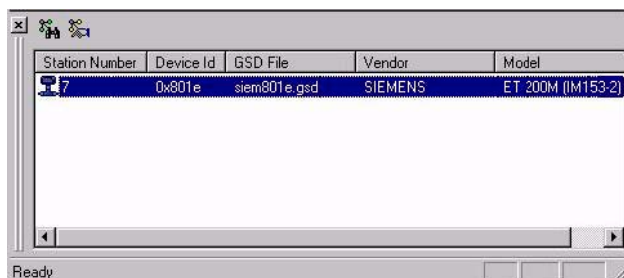

8. Right-click on each slave to assign a GSD file. A shortcut window displays with the following options:
 - **GSD Files** - Displays GSD file(s) found with the corresponding slave ID and a default-generated GSD file, in case no ID match found.
 - **Export GSD** - Export a GSD file that will be saved with a new name, which by default is the station number-slave ID.
 - **Edit GSD** - Edit the selected GSD file. The generated GSD is the default if another GSD file is not selected. The vendor and model name and slave-specific options such as freeze, sync, auto baud, set slave address and user parameters may be specified here.
 - **Properties** - Displays module information for the slave.



Note

To create a configuration with these slaves, there must first be a Master in the configuration. After a Master has been added the slaves may be dragged over from the DP library to the Network view.



9. Drag and drop each slave from DP View to the Network view.

4.4 Downloading Configuration

1. Verify that the PLC state is either PROG or OFF (Inhibited). Also, the Profibus state of the PB3-REM must be OFFLINE. These states can be read from the diagnostics page, opened via the edit menu.
2. Select Connect command from the context or Edit menu, or click on the first icon  on the tool bar.

If the configuration does not match what is currently in the scanner the following prompt will appear. To use the new configuration, select YES. To upload the configuration from the scanner, select NO.

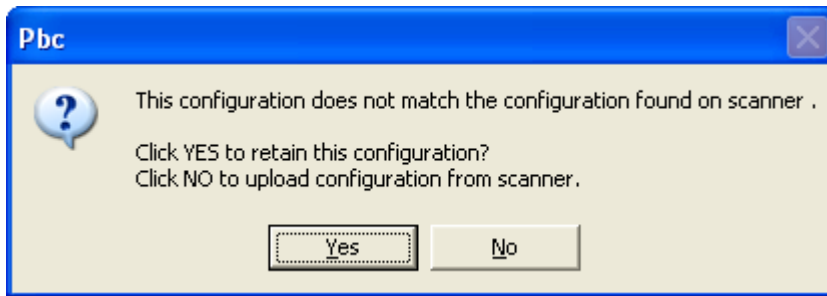

Any configuration mismatches are listed under the Master status.



3. Load the configuration to the Master by selecting the Load configuration  icon in the toolbar or use Load Configuration to Flash from the context or Edit menu.
4. If using tag mode a prompt will appear to save a L5X file will be displayed as below. For Manual mode this prompt will not occur.



Note

If only Profibus network parameters have been changed and the I/O mapping remains unchanged in the existing configuration, no prompt for saving the L5X file will appear.

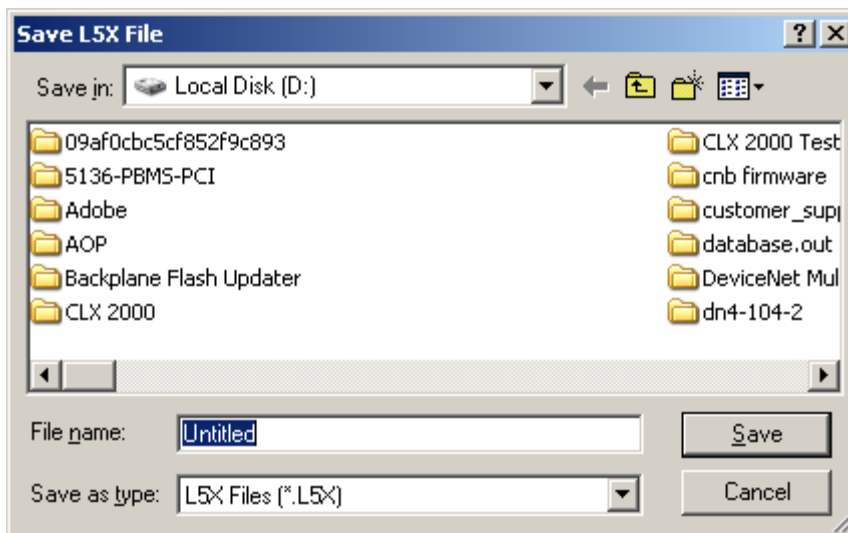



Note

In Tag mode, this L5X file will be used to import all UDTs and AOIs related to the Profibus configuration into RSLogix 5000. Anytime modifications are done to Profibus configuration such as adding or removing slaves, adding or removing I/O on slaves or changing slave station numbers, the L5X will need to be reimported into RSLogix5000 to update existing UDTs and AOIs related to the profibus configuration. Not doing so will result in uncontrolled behavior of slave's I/O. Refer to section [5.6, Importing the L5X File into RSLogix5000](#).

- The Master status now changes to the Configured Program state.



The SST-PB3-REM is now configured and ready to go to RUN mode.

- Right-click on the Master and select Disconnect from the shortcut menu to disconnect the module from the configuration tool.

4.5 Uploading Configuration

Prior to uploading configuration from the module it's recommended to add the slave GSD files to the device library that were used to build the configuration. Having all the required slave devices in the Device Library allows modification to the uploaded configuration such as adding more modules and changing details about a parameter.

Uploading configuration from module can be done while the state of the PLC is in RUN or PROGRAM with the module in Online or Offline mode. If the uploaded configuration will be modified and then downloaded, the PLC state needs to be either PROG or OFF (Inhibited) and the Profibus state is offline.



Note

When uploading configuration files in tag mode with bit definitions, the bit definitions are no longer available. Therefore the I/O CRC from the uploaded configuration will not match the original I/O CRC.

1. If slave GSD files that were used to build configuration are known, add them to the device library. (The following steps can still be followed if the slave GSD files are not known at the time. This may be done if the Slave GSD files are not available and the Slave IDs need to be determined in order to find the slave GSD files. The slave GSD filename will contain the Slave ID. For example, for the SST-PB3-REM slave ID is 0x0D10 and the GSD filename is ssti0D10.gse.



Note

When uploading configuration file without the required slave GSD files in Device Library the slave device name will appear as Unknown and no additional I/O and parameter identification will be possible.

2. Drag over the SST-PB3-REM Master from the device library to the network configuration window.
3. Select the module I/O mapping mode when prompted.
4. In the SST-PB3-REM Master Dialog box under “Local Interface Card” enter the IP address of the network interface card in PC.
5. Enter the IP Address of the Remote Module. If the IP Address is not known select the “Browse for Devices” button and select the Browse Button.
6. Once the SST-PB3-REM is detected, double-click on the module to select it.
7. Click OK button to close the SST-PB3-REM MASTER properties dialog box.
8. Right-Click on the SST-PB3-REM and select Connect.
9. When prompted with the following message, select No.

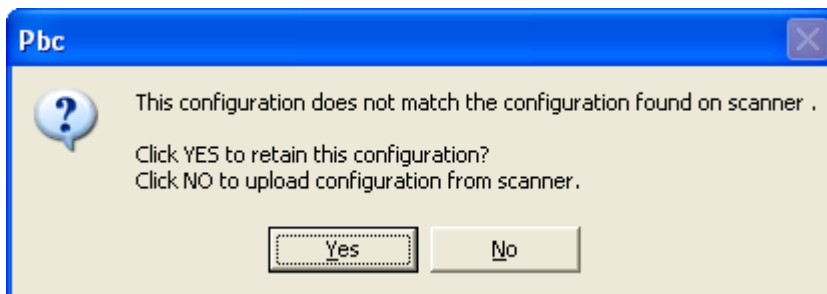

10. Another prompt may appear as the following if the mapping mode selected for the offline configuration is different from what was read from the configuration file in flash.

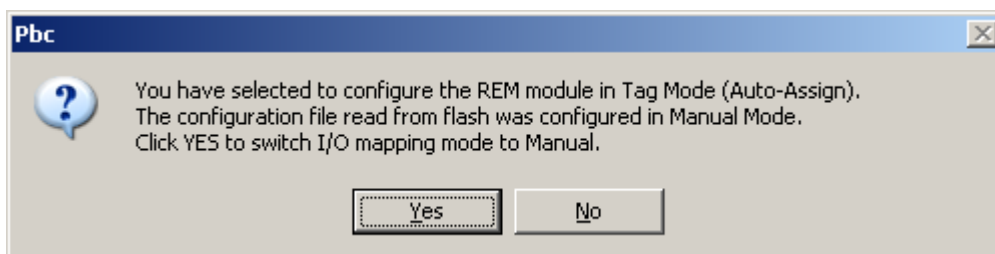

11. Select appropriate choice regarding the mapping mode.
12. The configuration should now be uploaded.

4.6 Exported L5X File Contents

The file contains the master configuration UDT, as well as two AOIs, one for copying data between the EtherNet/IP assemblies and the controller tag of type UDT and the other for validating the L5X file itself.

4.6.1 Master Configuration UDT

The master configuration UDT is a collection of structures (lower level UDTs) corresponding to the Profibus devices present in the configuration.

The highest level UDT name is the SST-PB3-REM master name defined in the configuration tool, for example, the default name set by the application for the first master (a configuration may contain multiple masters) is SST_PB3_REM_MASTER. Note that at configuration time this name may be changed in accordance with the RSLogix5000 tag naming rules.

The master UDT contains three tags with invariable names:

- IN – of type *Master_Name_IN*, where *Master_Name* is the name defined in the configuration tool.
- OUT – of type *Master_Name_OUT*, where *Master_Name* is the name defined in the configuration tool.
- STATUS – of type STATUS_TYPE.

Master_Name_IN – is the UDT that contains the mapping of all defined EtherNet/IP input assemblies. It contains the following tags:

- Module_Status – of type INT, the name of this tag is invariable.
- Module_CMD_Reply – of type INT, the name of this tag is invariable.
- *Device_Name_n* – of type *Master_Name_IN_Devicen* where *Device_Name* is the slave name defined at configuration time, and *n* is the Profibus station number of the device.

Master_Name_OUT – is the UDT that contains the mapping of all defined EtherNet/IP output assemblies. It contains the following tags:

- CMD_Control – of type INT, the name of this tag is invariable.
- CMD_Arguments – of type INT, the name of this tag is invariable.
- *Device_Name_n* – of type *Master_Name_OUT_Devicen* where *Device_Name* is the slave name defined at configuration time, and *n* is the Profibus station number of the device.



Note

Device_Name_n tags in the Master_Name_IN and Master_Name_OUT UDTs are in Slave station number order. Make sure to reimport the L5X file every time the Profibus configuration is modified. Not doing so will result uncontrolled slave I/O. The only time reimporting is not necessary is when only the network parameters are modified.

STATUS_TYPE – is the UDT that contains the mapping of data defined in the EtherNet/IP status assembly. It contains the tags with the same names as seen in the status assembly structure, section 7.2, Input Only.

4.6.2 AOIs

The data copy AOI copies output data from a controller tag of type master UDT to the output assemblies and input data from the input assembly to the controller tag of type master UDT. It also copies the status information from the status assembly into a controller tag of type STATUS_TYPE.

The second AOI provided in the L5X file compares the I/O mapping CRC with the argument passed in by the ladder logic. This may be used to ensure the L5X file matches the configuration present in the module's flash.

For details on how to use the AOIs see [section 5.7](#).

Master Status

The Profibus master status may be viewed once a master is added to the Network view in the SST Profibus Configuration Tool, adjacent to the master name.

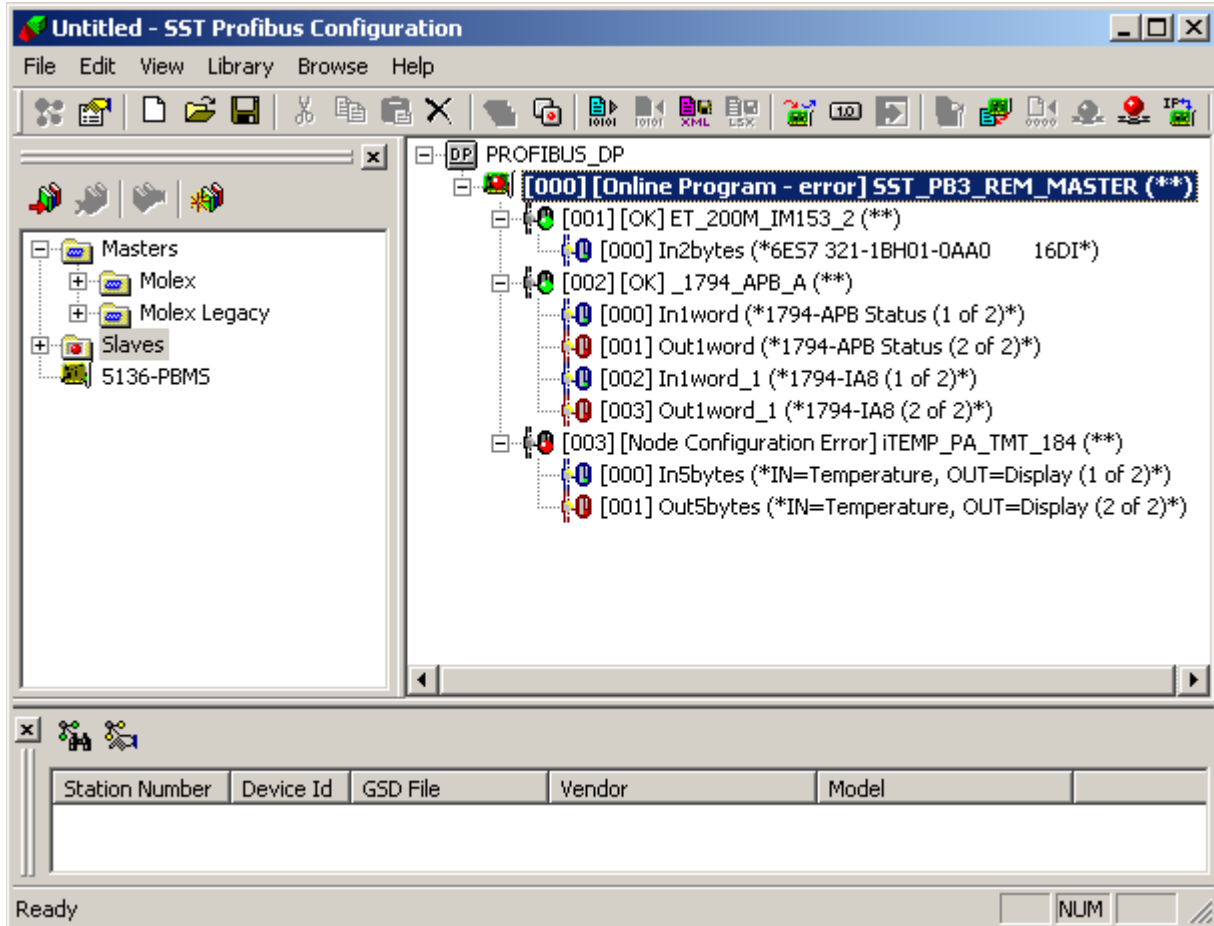

Possible states:

1. Disconnected – the configuration tool is not connected to SST-PB3-REM via Ethernet.
2. Configuration Mismatch – the configuration loaded in the application does not match the one present in the module's flash memory.
3. Configured Program – the configuration loaded in the application matches the one present in the module's flash memory. The module is not active on the Profibus network and its PLC state may be Off, Program or Run.
4. Online Program/Run – All OK – the module is online on the Profibus network, the PLC state of the module is Off or Program/Run and all Profibus slaves are scanned OK.
5. Online Program/Run – error – the module is online on the Profibus network, the PLC state of the module is Off or Program/Run, one or more Profibus slaves are in error.

6. Online Program/Run – Slave(s) Disabled – the module is online on the Profibus network, the PLC state of the module is Program/Run, all Profibus are scanned OK, but one or more slaves are disabled (via explicit messaging).
7. Not Configured – there is no master configuration present in the module’s flash memory.
8. HB Timeout – the connection heartbeat has timed out. The user must disconnect and reconnect.

4.7 Commands

The SST Profibus Configuration Tool commands are available on the tool bar, file menu, edit menu and on right-click on the master node in the Network view. Some of these commands are only available when connected to the master.

4.7.1 Print Preview

Available from the file menu. This option allows printing the details of the Network, Master and Slaves configured on Profibus network.

4.7.2 Get Offset Listing

Available from the tool bar,  or Get Offset Listing option in the master context and Edit menus.

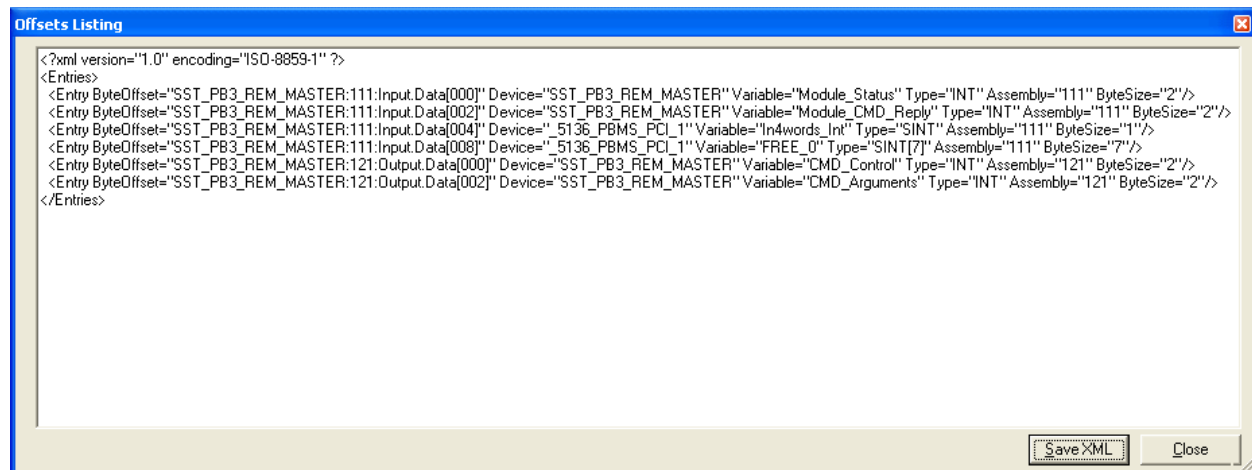

The option is available when a valid SST-PB3-REM master configuration is present in the Network view. It does not require a connection to the Remote Module.

Get Offset Listing provides a table of the Profibus I/O mappings within the EtherNet/IP assemblies. This option is useful when using the SST-PB3-REM module with non-Rockwell controllers, or versions of RSLogix5000 that do not support the use of AOIs/UDTs. The listing may be saved in XML format by clicking Save XML and later be imported into an Excel spreadsheet as seen below.

ByteOffset	Device	Variable	Type	Assembly	ByteSize
SST_PB3_REM_MASTER:111:Input.Data[000]	SST_PB3_REM_MASTER	Module_Status	INT	111	2
SST_PB3_REM_MASTER:111:Input.Data[002]	SST_PB3_REM_MASTER	Module_CMD_Reply	INT	111	2
SST_PB3_REM_MASTER:111:Input.Data[004]	_5136_PBMS_PCI_1	In4words_Int	SINT	111	1
SST_PB3_REM_MASTER:111:Input.Data[008]	_5136_PBMS_PCI_1	FREE_0	SINT[7]	111	7
SST_PB3_REM_MASTER:121:Output.Data[000]	SST_PB3_REM_MASTER	CMD_Control	INT	121	2
SST_PB3_REM_MASTER:121:Output.Data[002]	SST_PB3_REM_MASTER	CMD_Arguments	INT	121	2

4.7.3 Save L5X File

Available from the tool bar,  or Save L5X File option in the master context and Edit menus.

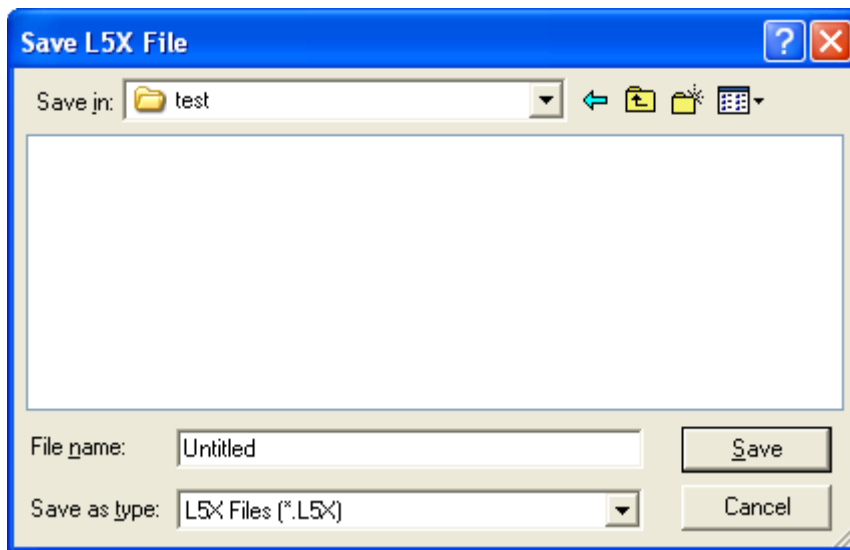

The option is available when a valid SST-PB3-REM master configuration is present in the Network view. It does not require a connection to the Remote Module.

Save L5X File generates an RSLogix5000 L5X file with the configured Profibus I/O mapping defined as UDTs as well as corresponding AOIs.

4.7.4 Download Firmware

Available from the toolbar,  or Download Firmware option in the master context and Edit menus.

The option is available when the configuration tool is connected to SST-PB3-REM, the controller state is Off and the Profibus state of the module is Offline.

Download Firmware provides a way to update firmware on the SST-PB3-REM:

- Locate the firmware file, SST-PB3-REM-x.y.z.w.BIN, where x.y.z.w represents the four digit version number. Select the file and click Open.

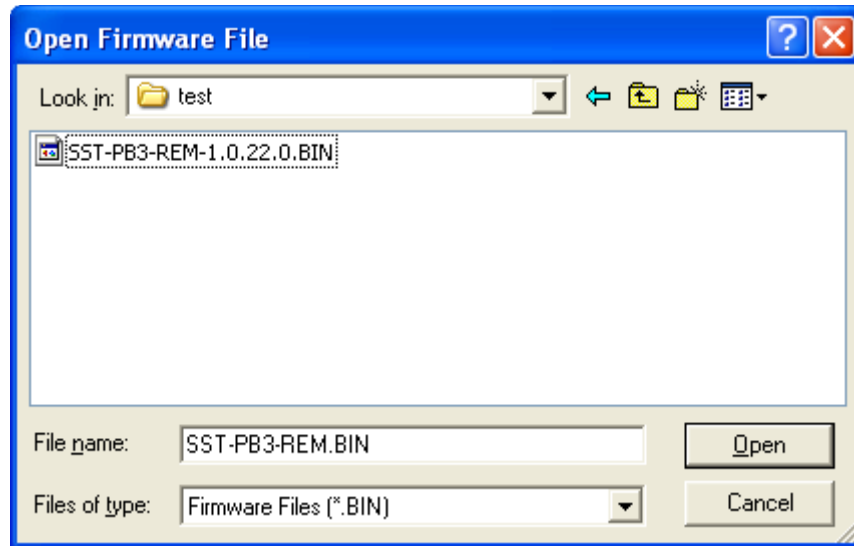

- Answer whether to continue with the download or abort. If the answer is yes, downloading will commence.

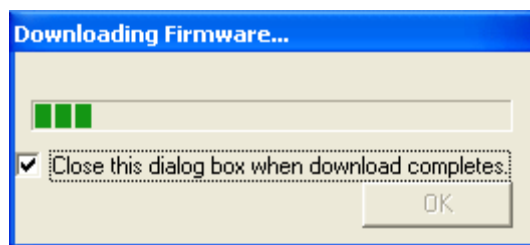

- When download completes the user is notified that the module is rebooting, the configuration tool automatically disconnects the module. Wait until the module finishes rebooting to reconnect.

4.7.5 Upload Configuration from Flash

Available from the toolbar,  or Upload Configuration from Flash option in the master context and Edit menus.

The option is available when the configuration tool is connected to SST-PB3-REM, a configuration exists in the module's flash, the controller state is Program or Off.

Upload Configuration from Flash uploads the configuration from the module's flash to the PC.

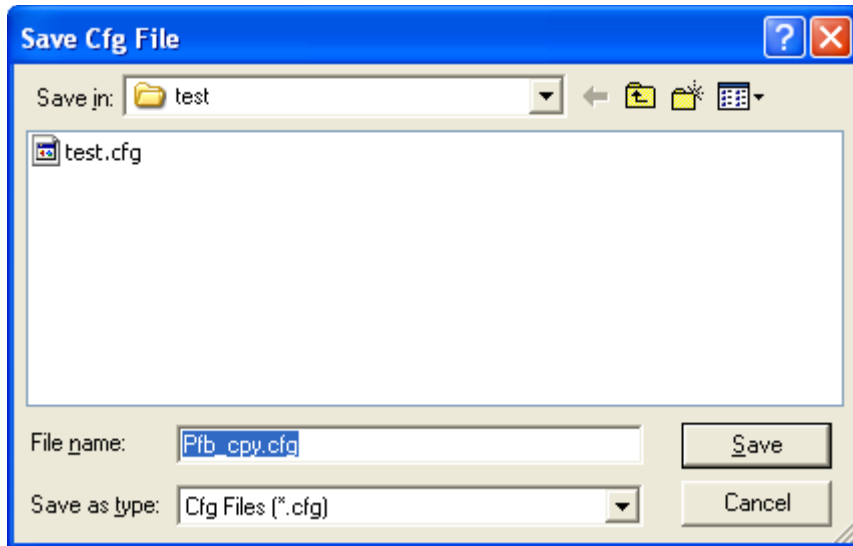

The user is prompted to save the configuration file, *.cfg, default name Pfb_cpy.cfg.

4.7.6 Erase Configuration

Available from the toolbar,  or Erase Configuration option in the master context and Edit menus.

The option is available when the configuration tool is connected to SST-PB3-REM, a configuration exists in the module's flash, the controller state is Off and the Profibus state of the module is Offline.

Following and Erase Configuration, the master state in the configuration tool changes to Not Configured.

4.7.7 Online

Available from the toolbar,  or Online option in the master context and Edit menus.

The option is available when the configuration tool is connected to SST-PB3-REM, a configuration exists in the module's flash, the controller state is Program or Off and the Profibus state of the module is Offline.

Online command will make the module active on the Profibus network.

4.7.8 Offline

Available from the toolbar,  or Offline option in the master context and Edit menus.

The option is available when the configuration tool is connected to SST-PB3-REM, the controller state is Program or Off and the Profibus state of the module is not Offline.

Offline command will take the module off the Profibus network.

4.7.9 Get/Set IP Address

Available from the toolbar,  or Get/Set IP Address option in the master context and Edit menus.

The option is available when the configuration tool is connected to SST-PB3-REM.

Get/Set IP Address allows viewing and altering of the EtherNet/IP TCP/IP Interface and Ethernet Link objects' settings.

Note that any changes in the IP Address section will take effect after a module reset. The Reset button is available only when the controller is in Program or Off mode.

To configure the IP Address:

- Click Get to retrieve the current TCP/IP Interface settings.
- Enter new IP Address in the IP Address field.
- Enter new subnet mask in the Subnet Mask field.
- Enter new gateway address in the Default Gateway field.
- Alternatively, check the DHCP checkbox to enable the Remote Module to obtain its configuration via DHCP.

- Click Set to apply the changes, a message box notifying that the settings will take effect after module reset will appear.
- Reset the module by clicking the Reset button. The configuration tool will automatically disconnect from the Remote Module. Wait until reset completes before attempting to reconnect.

To configure the port(s):

- Check Auto-Negotiate Port Speed and Duplex checkbox to automatically set these values from the network. This also disables Port Speed and Duplex list boxes.
- Select one of the available port speeds: 10 Mbps or 100 Mbps.
- Select one of the available Duplex values: Half or Full.
- Current Port Speed and Current Duplex display the current port speed and duplex at which the module is currently operating.

4.7.10 Module Diagnostics

Available in the master context and Edit menu, Diagnostics option.

The option is available when the configuration tool is connected to SST-PB3-REM.

There are two diagnostics pages:

- Basic Diagnostics – basic information about the Remote Module.
- PLC Connection – information about the EtherNet/IP connections and controller state.

Save button on the Basic Diagnostics page allows the user to save diagnostics information from both pages (not only Basic Diagnostics).

Reset button on the PLC Connection page resets the diagnostics counters on this page.

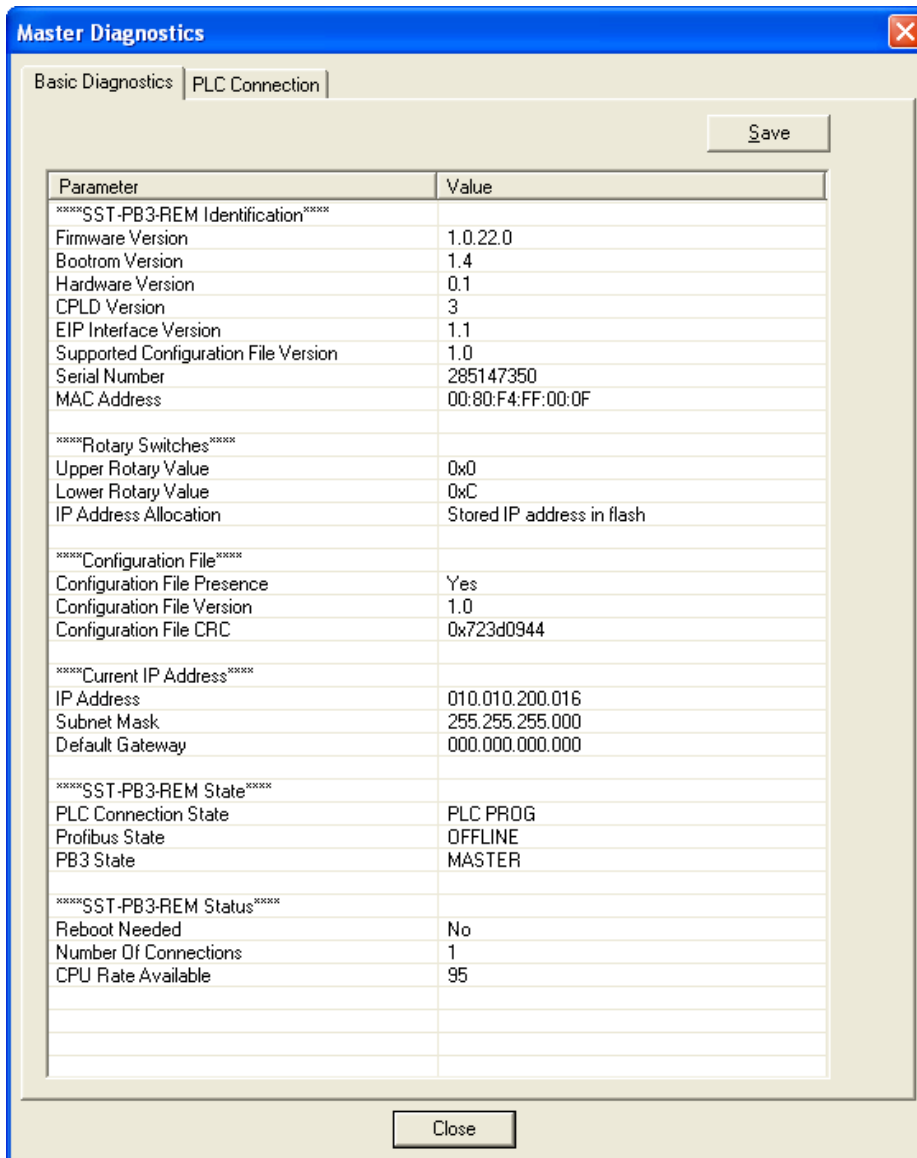

SST-PB3-REM Identification section lists general information about the Remote Module.

Rotary Switches section:

- Upper Rotary Value – setting of the upper rotary switch located at the rear of the module and it is a value ranging from 0x0 to 0x0F.
- Lower Rotary Value – setting of the lower rotary switch located at the rear of the module and it is a value ranging from 0x0 to 0x0F.
- IP Address Allocation may be one of the following:
 - Current address obtained from DHCP server – the module obtains its address from a DHCP server.
 - Factory IP used (A or B) – lower rotary switch is in position A or B.
 - Stored IP address in flash – the module uses a static IP address stored in flash.

Configuration File section:

- Configuration File Presence – indicates whether a Profibus master configuration is present in flash.
- Configuration File Version – Profibus master configuration file format version.
- Configuration File CRC – CRC of the Profibus master configuration file.

Current IP Address section lists IP address configuration.

SST-PB3-REM State section:

- PLC Connection State may be one of the following:
 - PLC OFF – no EtherNet/IP connection.
 - PLC PROG – at least one EtherNet/IP connection open, the controller state is PROG. Note that the actual controller may be in RUN mode, this is Remote Module controller state.
 - PLC RUN – at least one EtherNet/IP connection is open, the controller state is RUN.
- Profibus State may be one of the following:
 - OFFLINE – as a Profibus master, the module is not active on the Profibus network.
 - STOP – there is a CommDTM connection to the Remote Module.
 - OPERATE – as a Profibus master the module is active on the Profibus network and the controller state is RUN.
 - CLEAR – as a Profibus master the module is active on the Profibus network and the controller state is PROG.
- PB3 State may be one of the following:
 - MASTER – SST-PB3-REM is configured as a Profibus master.
 - NO CONF – no Profibus master configuration present in module's flash.

SST-PB3-REM Status section:

- Reboot Needed – always No.
- Number Of Connections – number of EtherNet/IP connections open.
- CPU Rate Available – percentage of CPU rate that remains available.

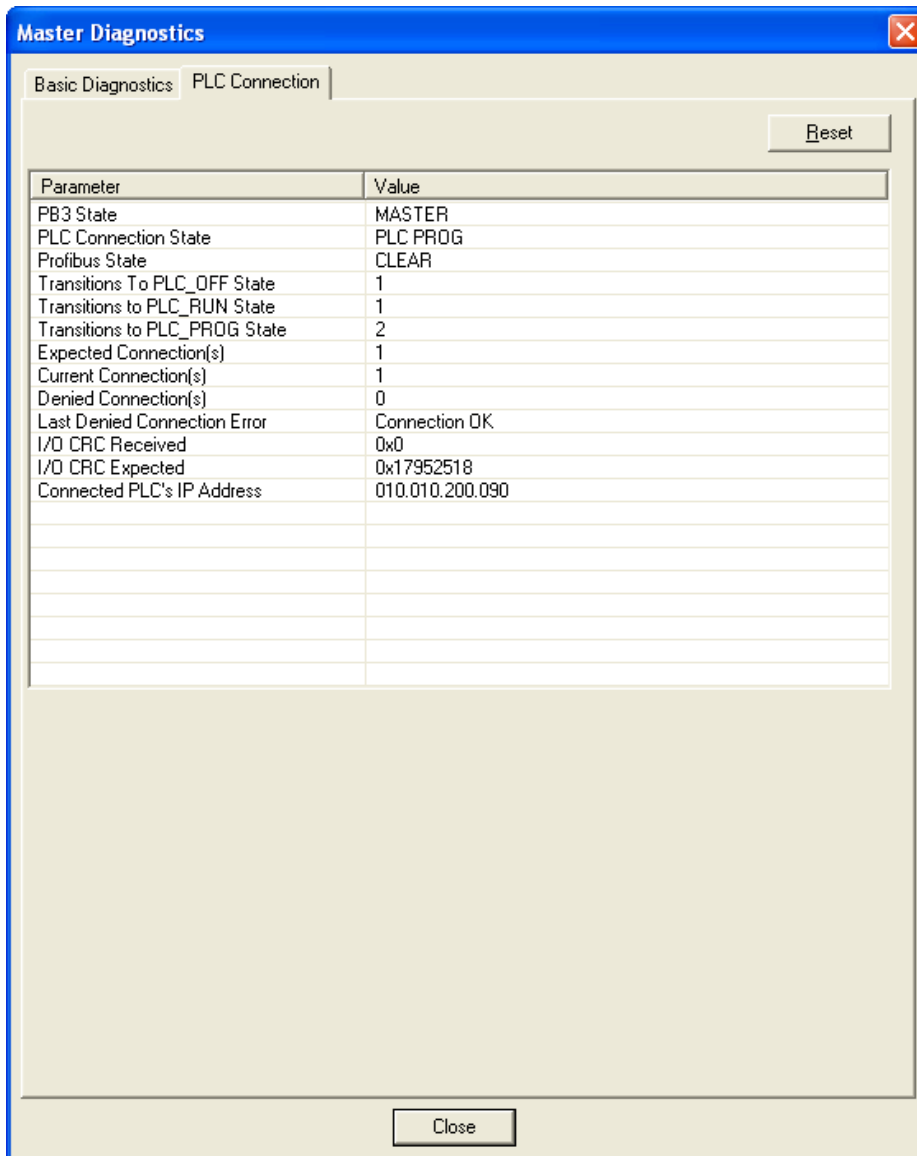

PB3 State, PLC Connection State, Profibus State – same as the fields with the same names on the Basic Diagnostics page.

Transitions to PLC_OFF State – EtherNet/IP connection close counter.

Transitions to PLC_RUN State – EtherNet/IP connections transitioning to RUN mode counter.

Transitions to PLC_PROG State – EtherNet/IP connections transitioning to PROG mode counter.

Expected Connection(s) – number of EtherNet/IP connections expected as per the module configuration.

Current Connection(s) – number of EtherNet/IP connections currently open.

Denied Connection(s) – number of denied EtherNet/IP connections.

Last Denied Connection Error may be one of the following:

- Connection OK – no error.
- Connection Denied Due To Bad CRC – I/O CRC entered in the connection Configuration parameter did not match the I/O CRC of the configuration in flash.
- Connection Not Possible While No Configuration File – the controller is attempting to open a connection with Profibus master I/O assembly numbers, but there is no Profibus master configuration in flash.
- Slave Only Connection Not Possible In Master State – the controller is attempting to open a connection with Profibus slave only I/O assembly numbers, but there is a Profibus master configuration in flash.
- Connection Not Possible While ASM 111/121 Not Connected – the module denies connections with other I/O assembly numbers if assemblies 111 and 121 have not already been connected.
- Invalid Autorun Parameter – byte 1 of assembly 131 set to a value other than 0 or 1.
- Invalid Slave Input Size Parameter – byte 2 of assembly 131 set to a value outside of 0 to 244 range.
- Invalid Slave Output Size Parameter – byte 3 of assembly 131 set to a value outside of 0 to 244 range.
- Invalid Swapword Parameter – byte 4 of assembly 131 set to a value other than 0 or 1.
- I/O CRC Received – bytes 5-7 of assembly 131 are set to a value different than the I/O CRC of the configuration existing in flash.
- I/O CRC Expected – I/O CRC of the configuration existing in flash.

4.7.11 Export Binary

Available from the toolbar,  or Export Binary option in the master context and Edit menus.

The option is available when there is a valid Profibus network configuration in the Network view and allows exporting a SST-PB3-REM Profibus master configuration file (*.cfg) from the configuration tool on the PC.

4.7.12 Import Binary

Available from the toolbar,  or Import Binary option in the network context and Edit menus.

The option is only available when the Network view is empty and allows importing a SST-PB3-REM Profibus master configuration file (*.cfg) from the PC into the configuration tool.

1. Select File>New.
2. Right-click on Profibus_DP in the Network view and select Import Binary from the shortcut menu.

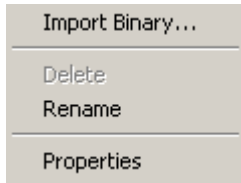

The Open window displays.

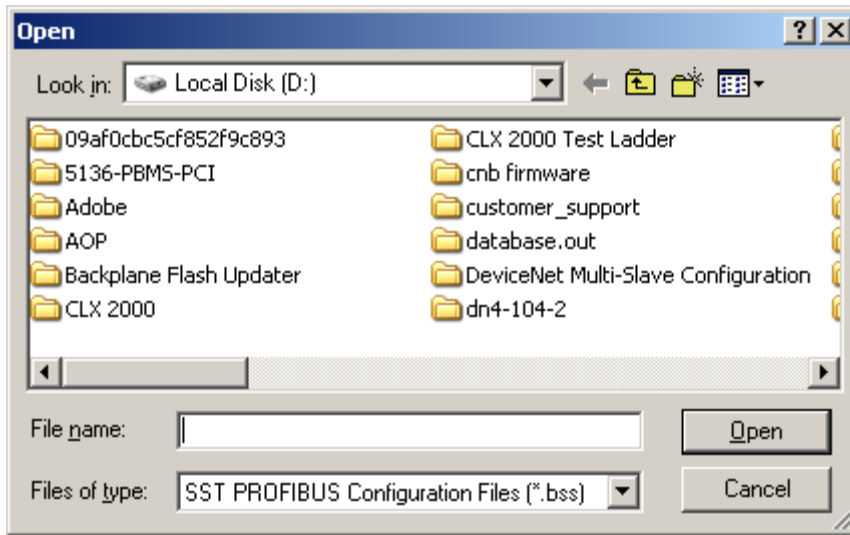

3. Change file type to PB3-REM Configuration Files (*.cfg)

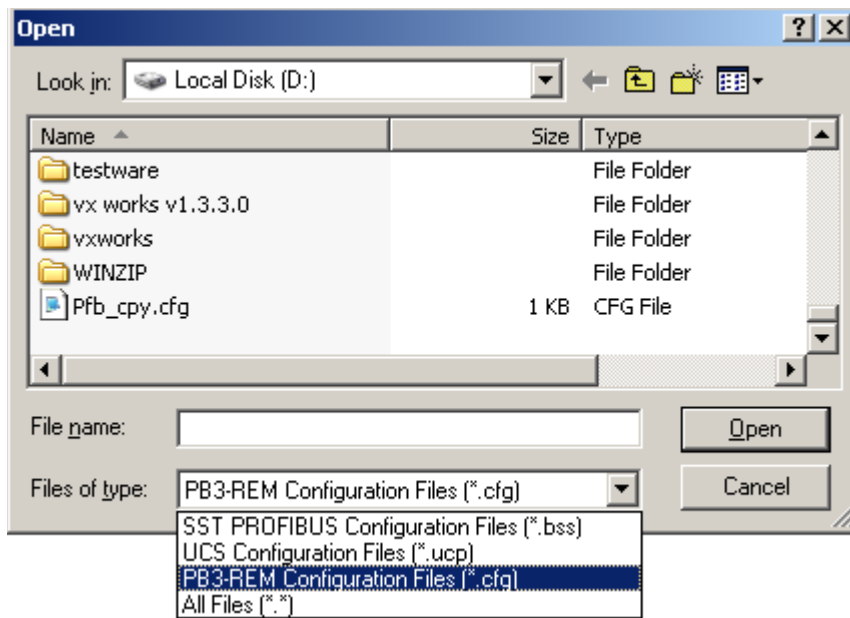

4. Browse for configuration file (*.Cfg) and select Open.

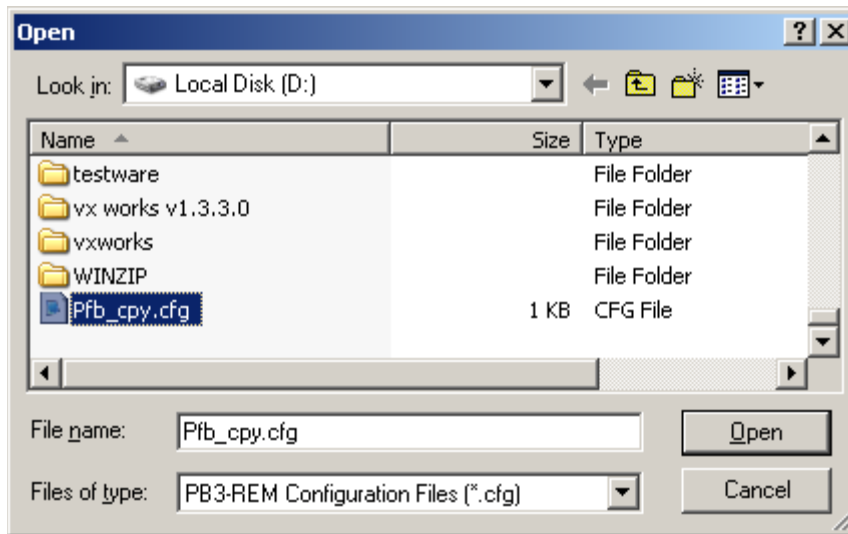

5. Import Wizard is displayed.

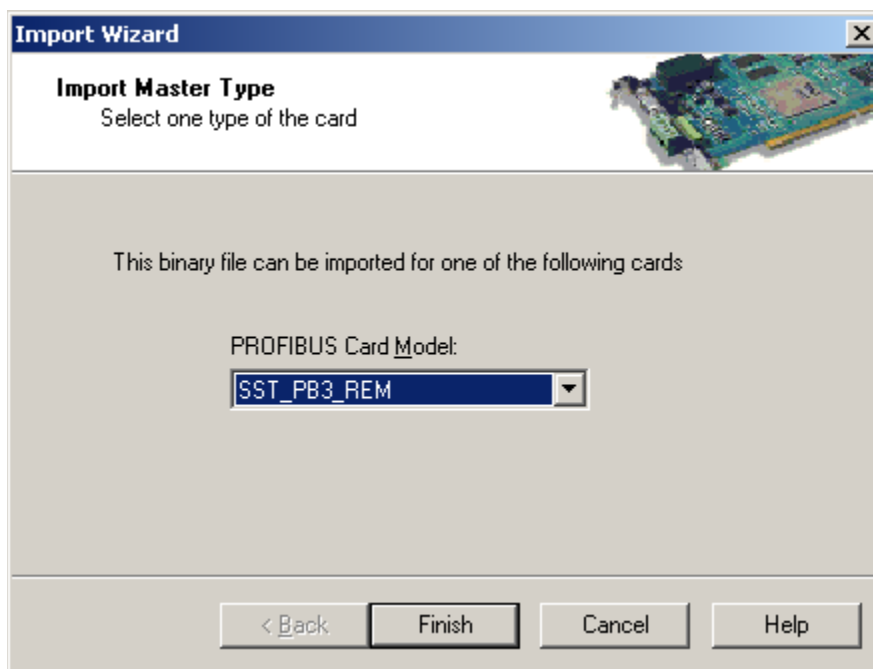

6. Select SST-PB3-REM.
7. Select the Next > or Finish >> button. If there are multiple GSD files for the same slave in the configuration, select the Next > button and follow the process to assign the correct GSD file to the slave.
8. When this is done, select Finish >>.
9. Select File > Save.

4.7.13 Device I/O Data

The option I/O Data is available from the slave context menu when the device is successfully scanned by the Profibus master.

Data may only be viewed, not edited. By default, data update rate is set to 1000 ms, other available options: 500 ms and 250 ms.

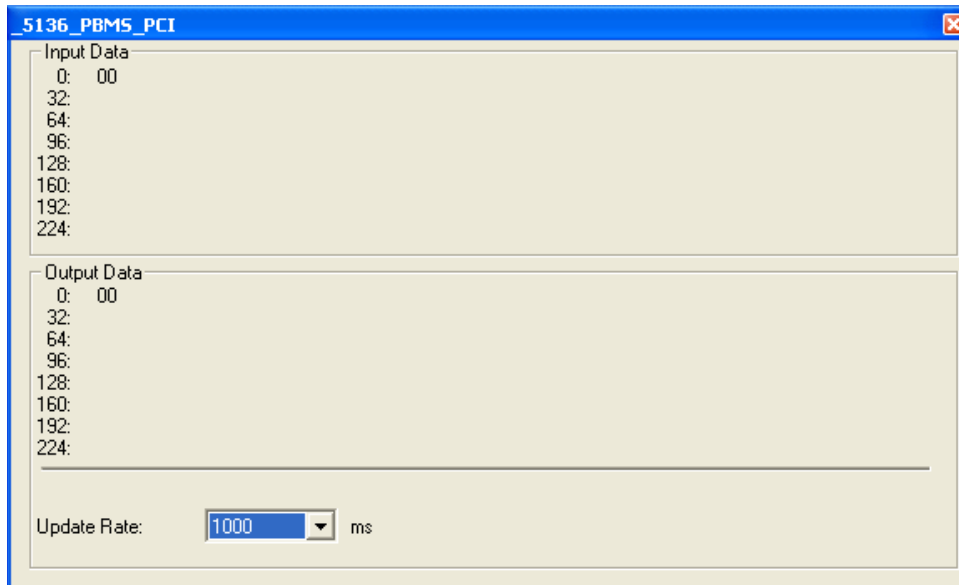

4.8 Connecting to Configured Master

1. Start a new configuration project, drag and drop the SST-PB3-REM master from Device Library view into the Network view. Alternatively open an existing configuration.
2. Connect to the master.

If the configuration does not match what is currently in the scanner and the scanner is not online on the Profibus network the following prompt will appear. To use the new configuration, select YES. To upload the configuration from the scanner, select NO.

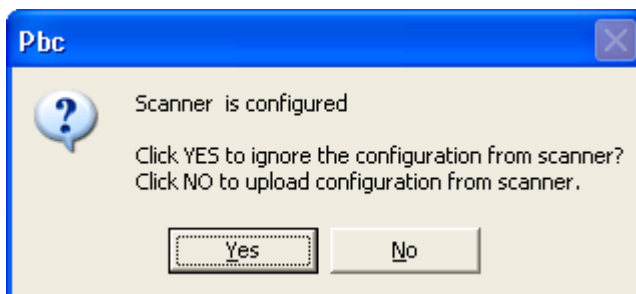

If the configuration does not match what is currently in the scanner and the scanner is online on the Profibus network the following prompt will appear. To use the new configuration, select YES. To upload the configuration from the scanner, select NO.

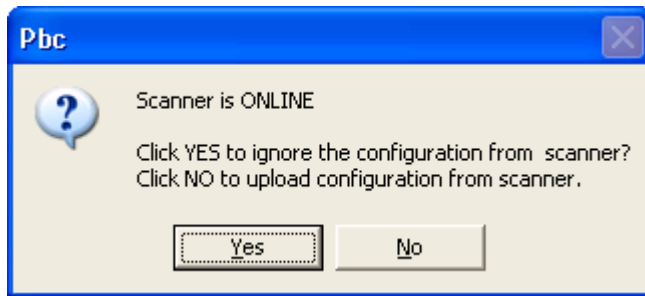

4.9 Diagnosing Slave Errors

1. To diagnose slaves in error (red status), right-click on the slave with the error.

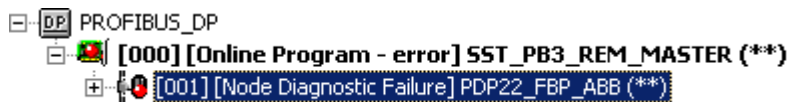

2. Select Diagnostics from the shortcut menu.



A Slave Diagnostics window displays, indicating the errors specific to that slave.

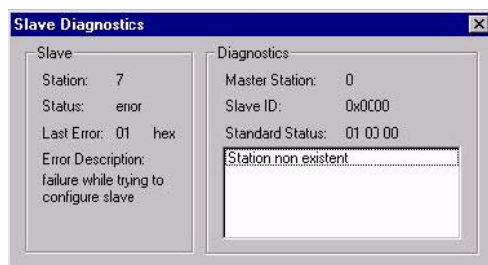

3. Troubleshoot the slave errors as required.

4.9.1 Station Non Existent

Check the slave's Profibus interface to ensure that it is powered on and connected to the Profibus network. Ensure that the slave supports the configured baud rate. Also, verify that the correct GSD is being used for the slave device.

4.9.2 Configuration Data Fault

Check that the I/O modules are configured in the order they appear in the slave device and that the I/O modules match the exact description of the modules selected (i.e., module serial number).

4.9.3 Station Not Ready

If there are still outstanding errors, this is always present. Also, the scan rate may be too high for the slave. This may be caused by using a wrong GSD file.

4.9.4 Extended Diagnostic Data

This is device specific. Retrieve the data by requesting the slave diagnostics in the RSLogix 5000 sample program. Extended diagnostic data starts at byte 7 of the slave diagnostics. Compare the values with the descriptions that may be available for the slave by viewing the slave's properties and selecting the Diagnostics tab in the Configuration Tool.

4.9.5 Function Not Supported

The slave does not support commands like SYNC or FREEZE coming from the Master. Check that the correct GSD file is being used.

4.9.6 Invalid Slave Response

This usually occurs when the slave is returning more diagnostic information than the Master can handle. Check the GSD file.

4.9.7 Parameter Fault

This usually means an incorrect Indent - Number or Invalid parameter has been sent to the slave. Check that the slave and module parameters are set correctly by selecting the Ext. Prms. tab under the slave/module's properties.

4.9.8 Master Lock

The DP slave has been parameterized by another Master. Take the controlling Master offline.

4.9.9 Param/Config Required

This remains present until the parameterization has completed properly. The GSD file may be incorrect or the slave and module parameters are not set to the correct values. Check the slave and module parameters by selecting the Ext. Prms. tab under the slave/module's properties.

4.9.10 Static Diagnostics

Check the slave diagnostic data by sending Slave Diagnostic Explicit Message (see section 9, Explicit Messaging). The first three bytes are the Profibus status bytes Station Status Byte 1, Station Status Byte 2, and Station Status 3.

4.9.11 DP Slave Set

This is OK and is set by the slave.

4.9.12 WatchDog

This is OK and should be set when the slave status is OK.

4.9.13 Ext Diags Overflow

More Diagnostic data is being returned from the slave than what is specified in its GSD file. The GSD file may be incorrect.

5

Configuring the SST-PB3-REM Profibus Master in RSLogix5000

Chapter Sections:

- RSLogix5000 Configuration Overview
- Configuring the SST-PB3-REM as a Generic EtherNet/IP CIP Bridge
- Registering SST-PB3-REM EDS file
- Changing the Ethernet Port Configuration of the SST-PB3-REM in RSlinx
- Configuring the SST-PB3-REM via EDS AOP (Add-on-Profile) in Studio 5000 Version 21
- Importing the L5X File into RSLogix5000
- Using Provided AOIs
- PLC Connection Error Codes

5.1 RSLogix5000 Configuration Overview

The SST-PB3-REM connects to Logix™ systems through EtherNet/IP™. RSLogix5000 version 16 and higher is required in order to be able to use the L5X file exported by the configuration tool. The Ethernet Bridge is configured first before creating the CIP connections to the module. In ControlLogix systems, processors such as L55 and higher and Ethernet bridge modules such as 1756-ENBT or 1756-EN2T can be used.

For CompactLogix systems, processors with Ethernet ports such as 1769-L23E, 1769-L32E and 1769-L35E can be used or if the processor does not have an Ethernet port but does support 1768 Bus, a 1768-ENBT can be used. Once the Ethernet port is configured, an Ethernet Bridge can be configured using the IP address configured on the SST-PB3-REM. Lastly, up to 4 Generic CIP connections can be configured using the specified assembly numbers for each connection (see section [1.3](#), EtherNet/IP Assemblies Overview).

The SST™ Profibus Configuration Tool will determine how many Generic CIP module connections are required. This can be viewed by going to Master Properties and selecting the Parameters tab.

5.2 Configuring the SST-PB3-REM as a Generic EtherNet/IP CIP Bridge



Note

When configuring the scanner, ensure that the controller is in Program mode.

1. Create a new program offline.
2. Select the 1769 CompactLogix Controller as the Controller type.
3. The I/O configuration will appear as below.

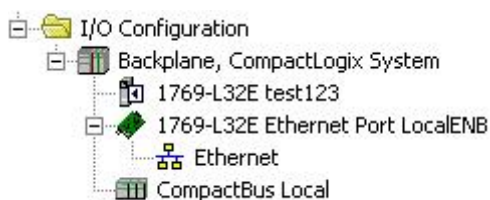

4. Right-Click on Ethernet and select New Module.

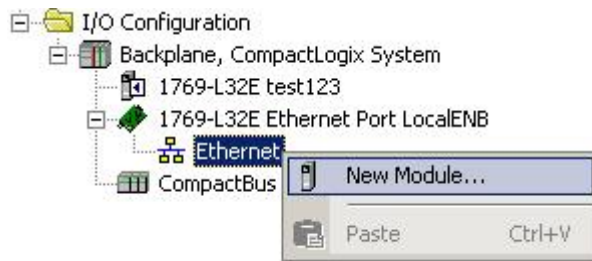

5. Select ETHERNET-BRIDGE in Select Module Dialog box

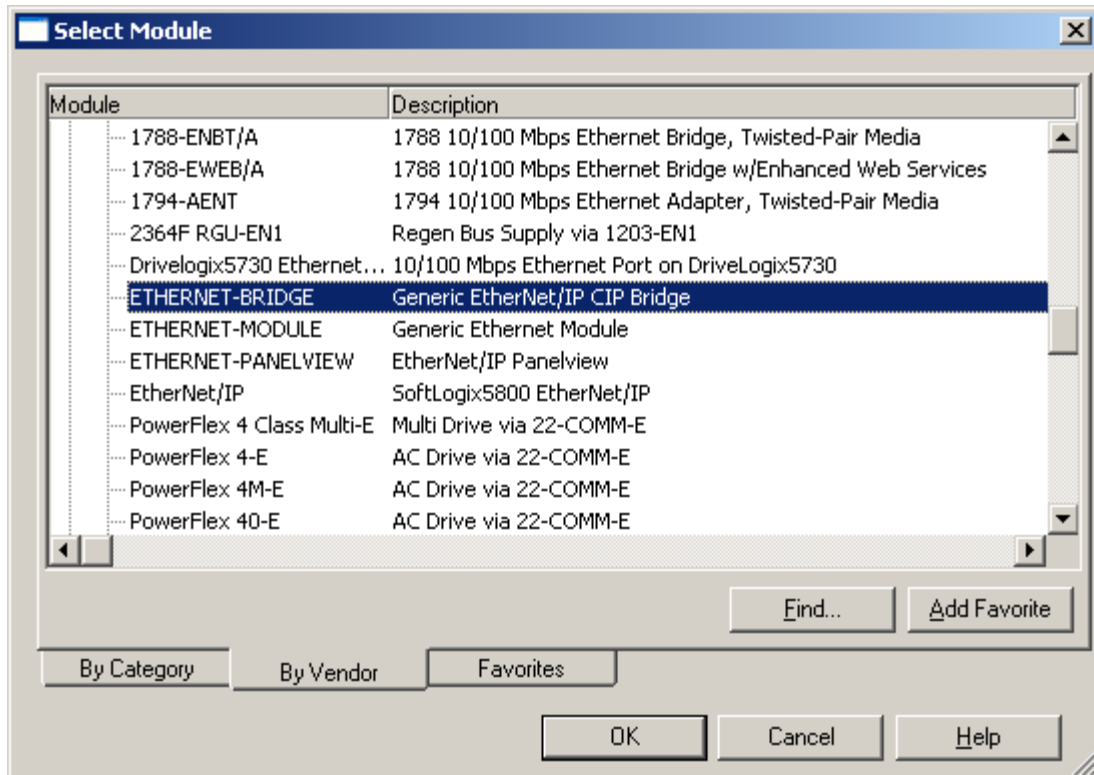

6. Enter the Name for the Ethernet Bridge and enter the IP address for the SST-PB3-REM.

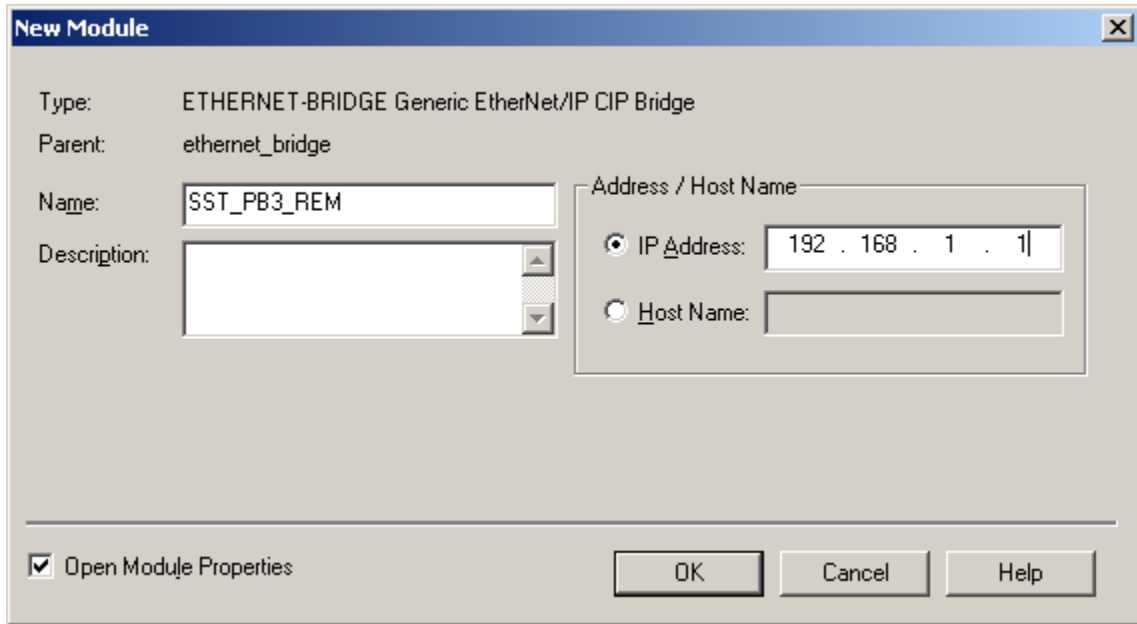

7. Click OK.
8. The I/O configuration should look like below. Right-Click on CIP Bus and Select New Module.... to begin configuring the CIP connections

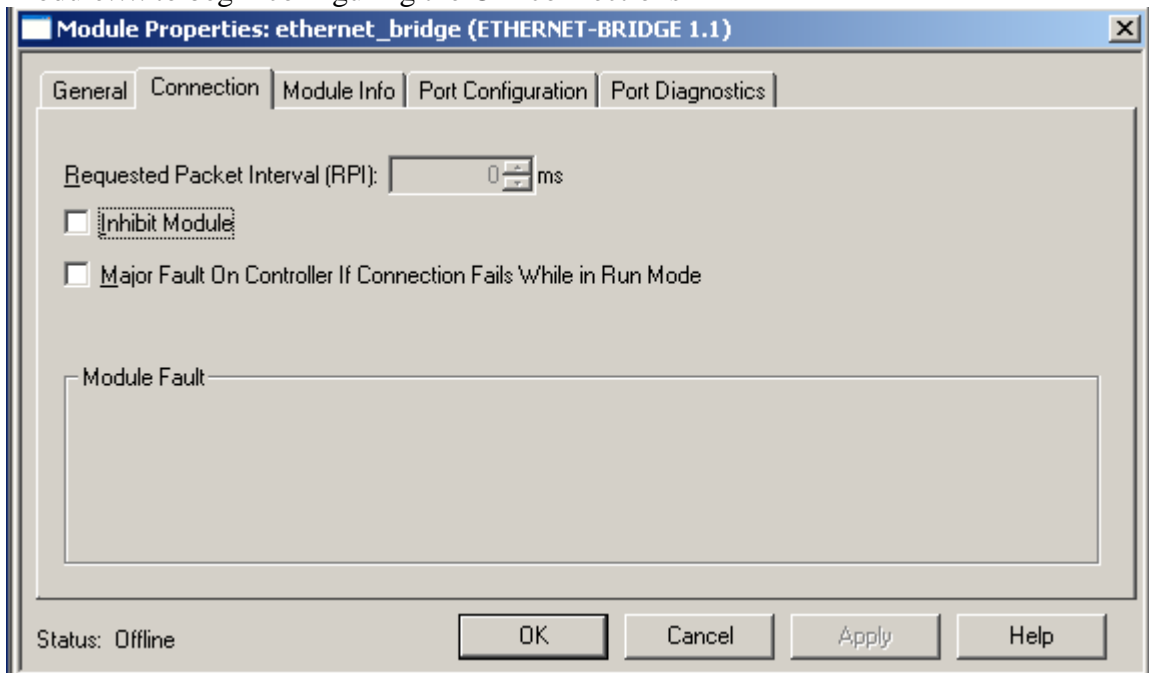

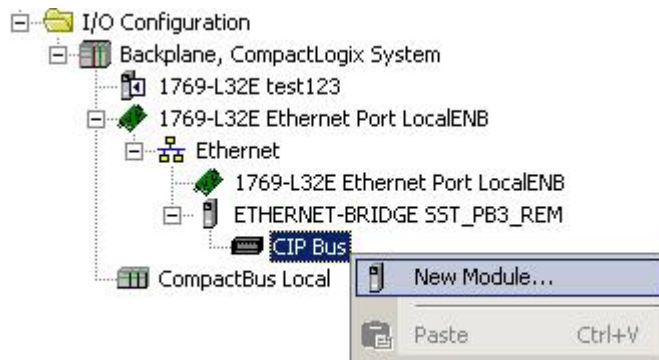

9. Select CIP Module and Click OK.

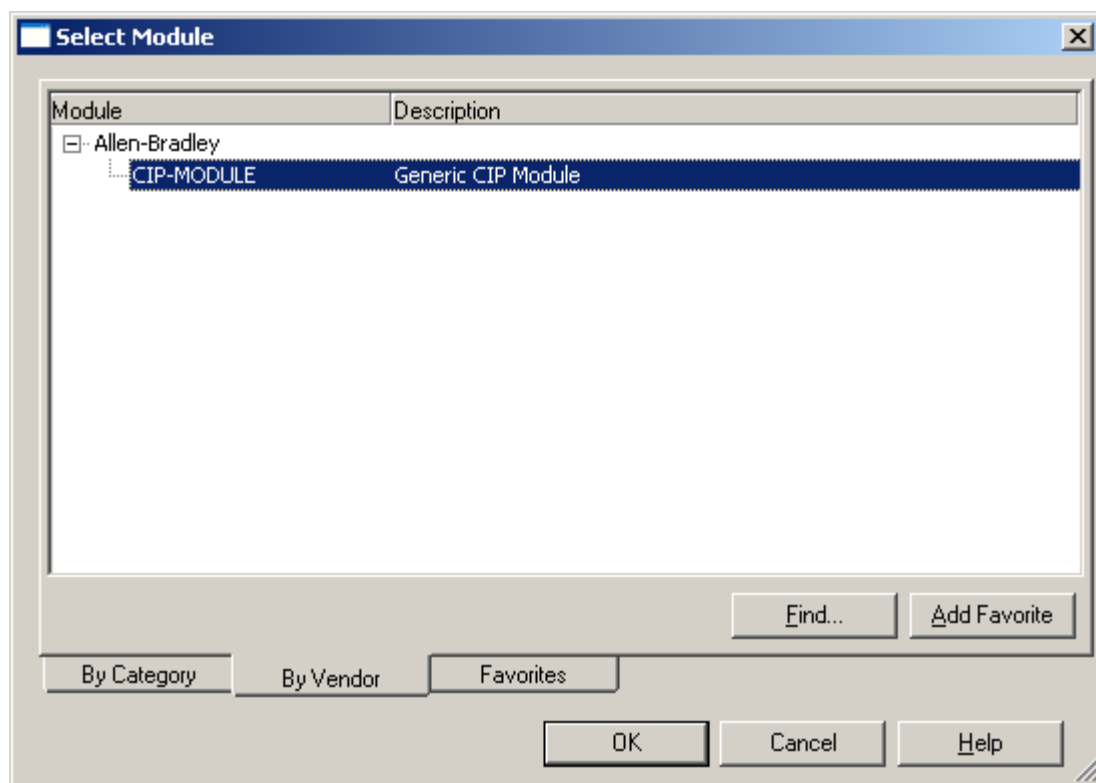

10. Enter Name and select Data – SINT – With Status and leave Address at 0. Enter Assemblies and sizes as below. For more details on I/O interface see section 6, EtherNet/IP Assemblies.

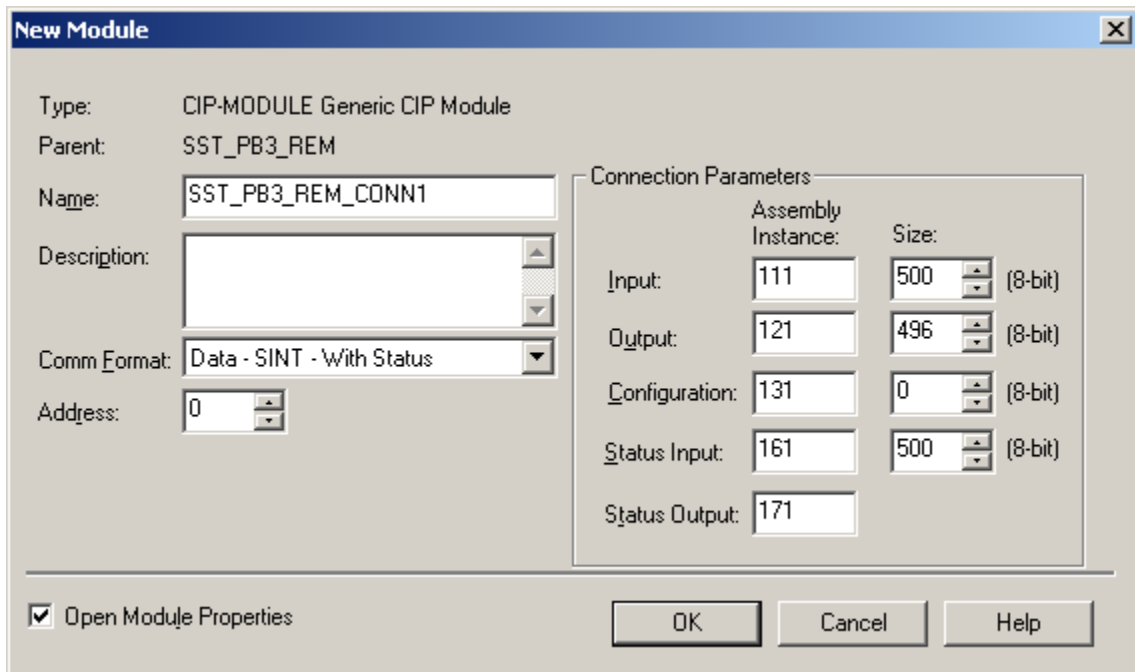

11. Configure RPI. Recommended RPI may be viewed in the SST Profibus Configuration Tool, master Parameters.

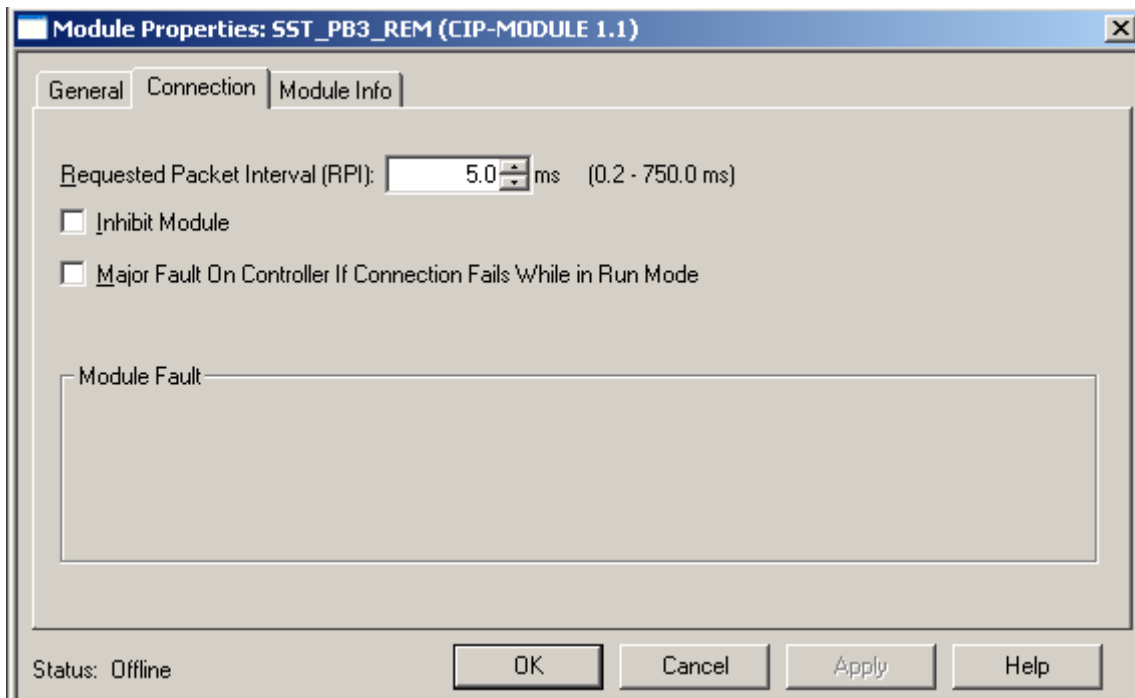

12. The first Exclusive Owner CIP connection is now configured.

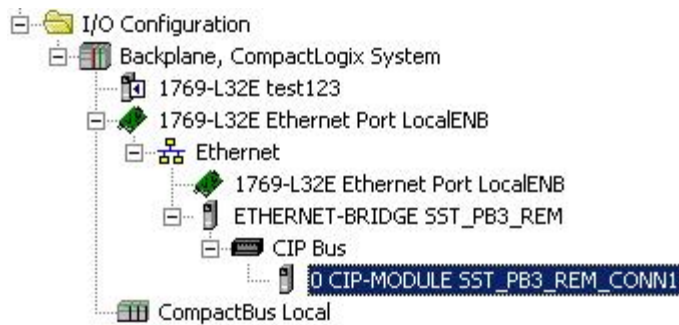

Up to 3 more Exclusive Owner CIP connections can be configured if the configuration requires 4 input and 4 output assemblies.

Use **Data-SINT** for Comm Format for other input assemblies (112,113 and 114) and output assemblies (122, 123 and 124) since status is already configured for the first Exclusive Owner connection.

Below is an example using all 4 Exclusive Owner CIP connections. Input and output sizes should match what is displayed in the SST Profibus Configuration Tool for the Master configuration under Master Properties, Parameters tab.

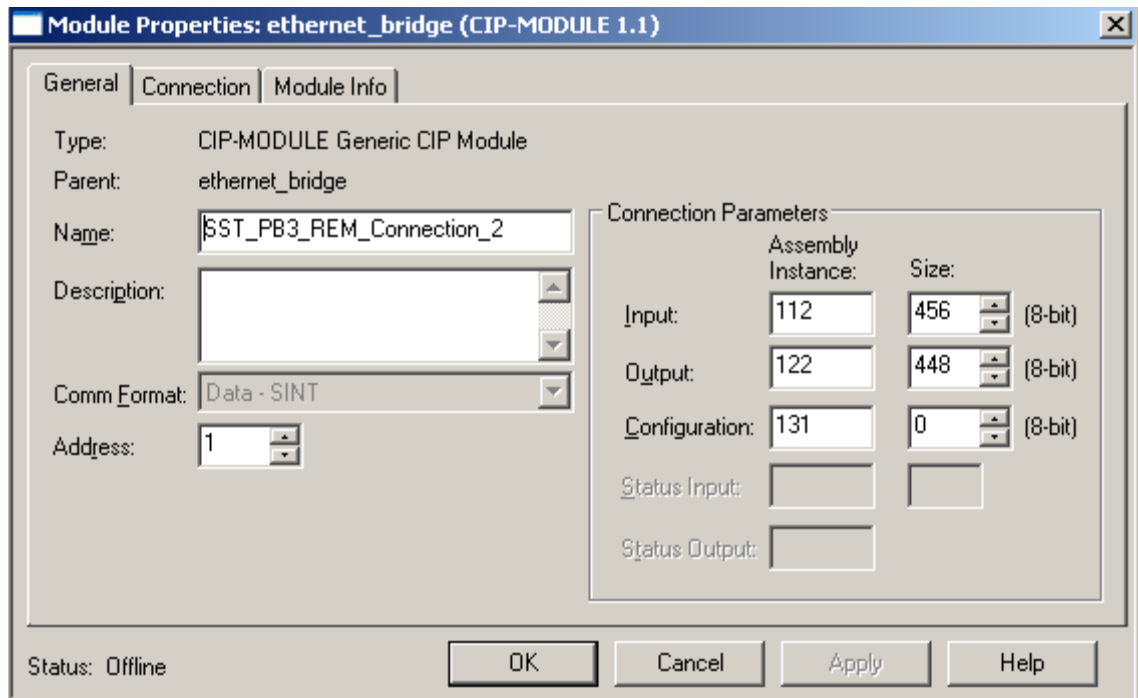
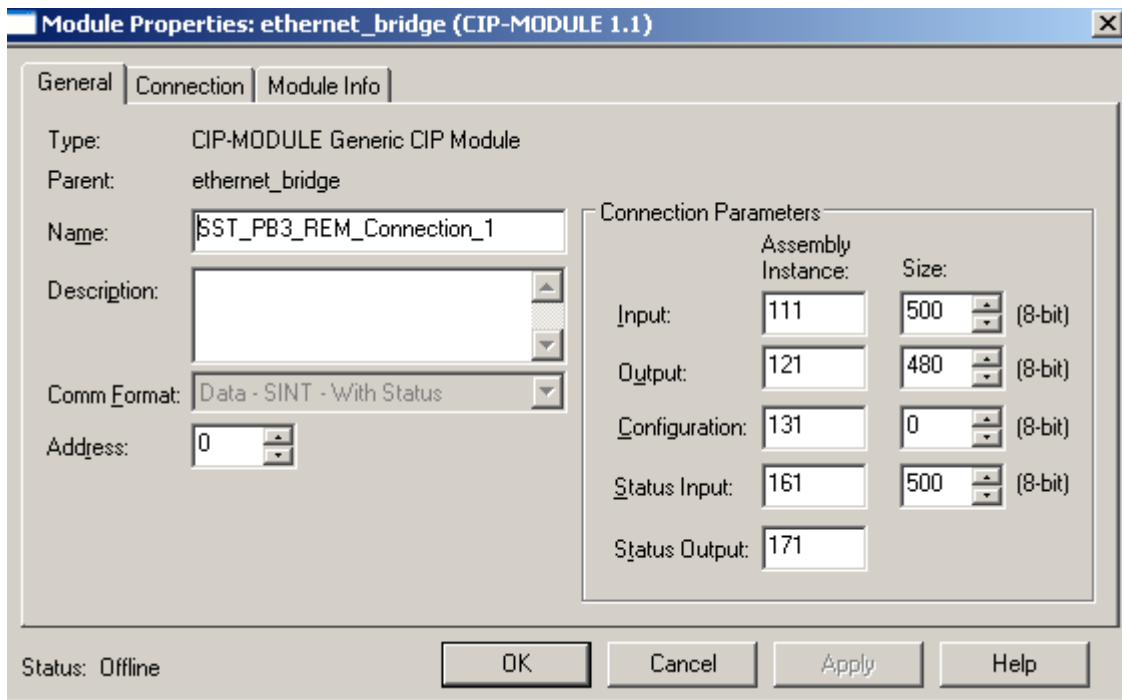

Module Properties: ethernet_bridge (CIP-MODULE 1.1)

General | Connection | Module Info

Type: CIP-MODULE Generic CIP Module
 Parent: ethernet_bridge

Name: SST_PB3_REM_Connection_3

Description:

Comm Format: Data - SINT

Address: 2

Connection Parameters

	Assembly Instance:	Size:	
Input:	113	448	(8-bit)
Output:	123	448	(8-bit)
Configuration:	131	0	(8-bit)
Status Input:			
Status Output:			

Status: Offline

OK Cancel Apply Help

Module Properties: ethernet_bridge (CIP-MODULE 1.1)

General | Connection | Module Info

Type: CIP-MODULE Generic CIP Module
 Parent: ethernet_bridge

Name: SST_PB3_REM_Connection_4

Description:

Comm Format: Data - SINT

Address: 3

Connection Parameters

	Assembly Instance:	Size:	
Input:	114	448	(8-bit)
Output:	124	128	(8-bit)
Configuration:	131	0	(8-bit)
Status Input:			
Status Output:			

Status: Offline

OK Cancel Apply Help

5.3 Registering SST-PB3-REM EDS file

The following steps were done using Rockwell's Studio 5000 Version 21 and RSLinx version 3.51. To use the EDS AOP for the SST-PB3-REM Remote Module, Studio 5000 Version 21 or higher is required.

With Studio 5000 there are two ways to register the EDS file. If you have the SST-PB3-REM connected to your Ethernet network and it's shown under the Ethernet/IP driver in RSLinx as below then the EDS file can be uploaded from module into RSLinx. The other way to register the EDS file is to use Rockwell's EDS hardware Installation Tool. This tool can be used when browsing for the SST-PB3-REM on the Ethernet network is not possible.

5.3.1 Registering EDS file via Upload EDS file from device using RSLinx

1. Launch RSLinx
2. Enable Autobrowse if not already selected.
3. Highlight and Right-Click on SST-PB3-REM.

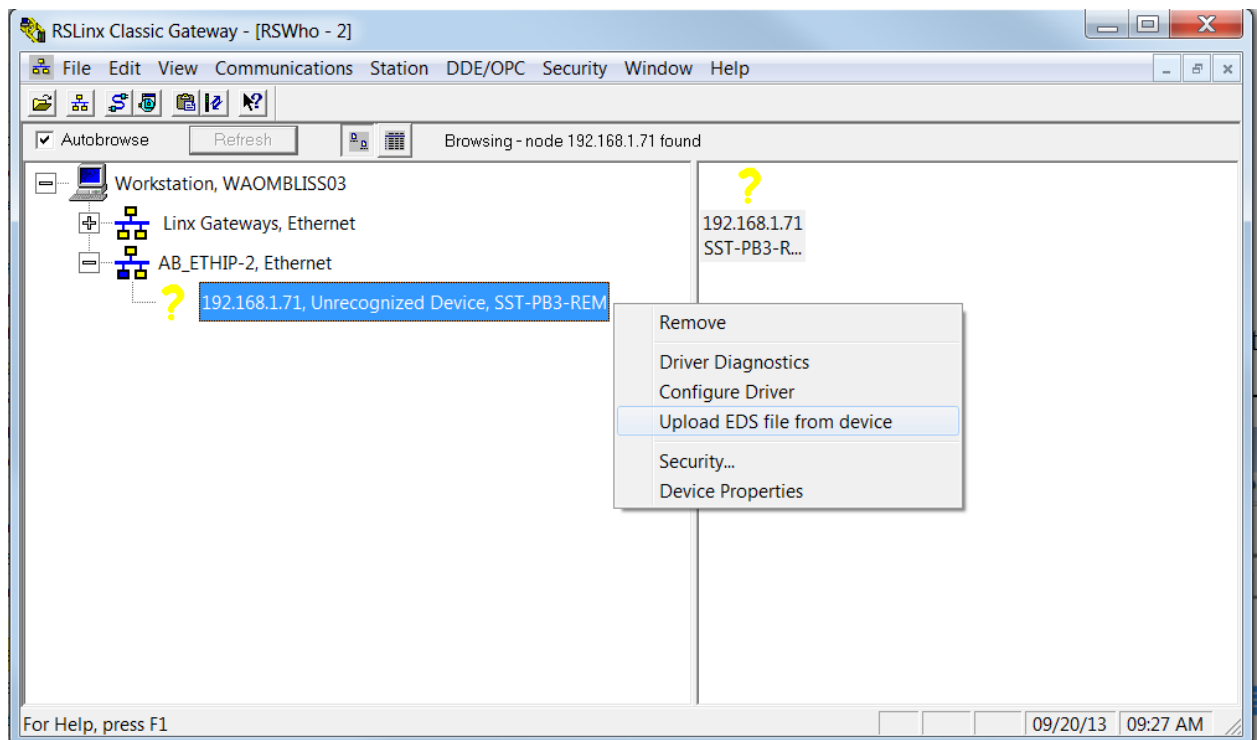

4. Select Upload EDS file from device.



5. The EDS wizard is displayed. Select the Next button.

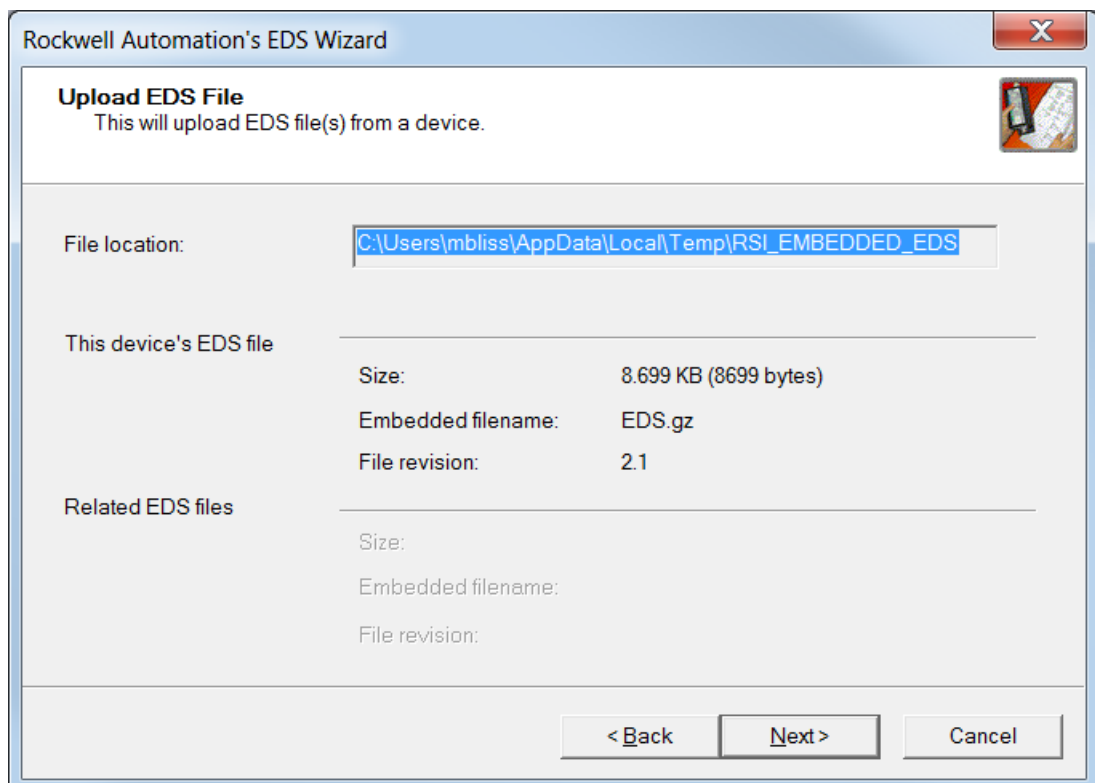

6. Select the Next button.

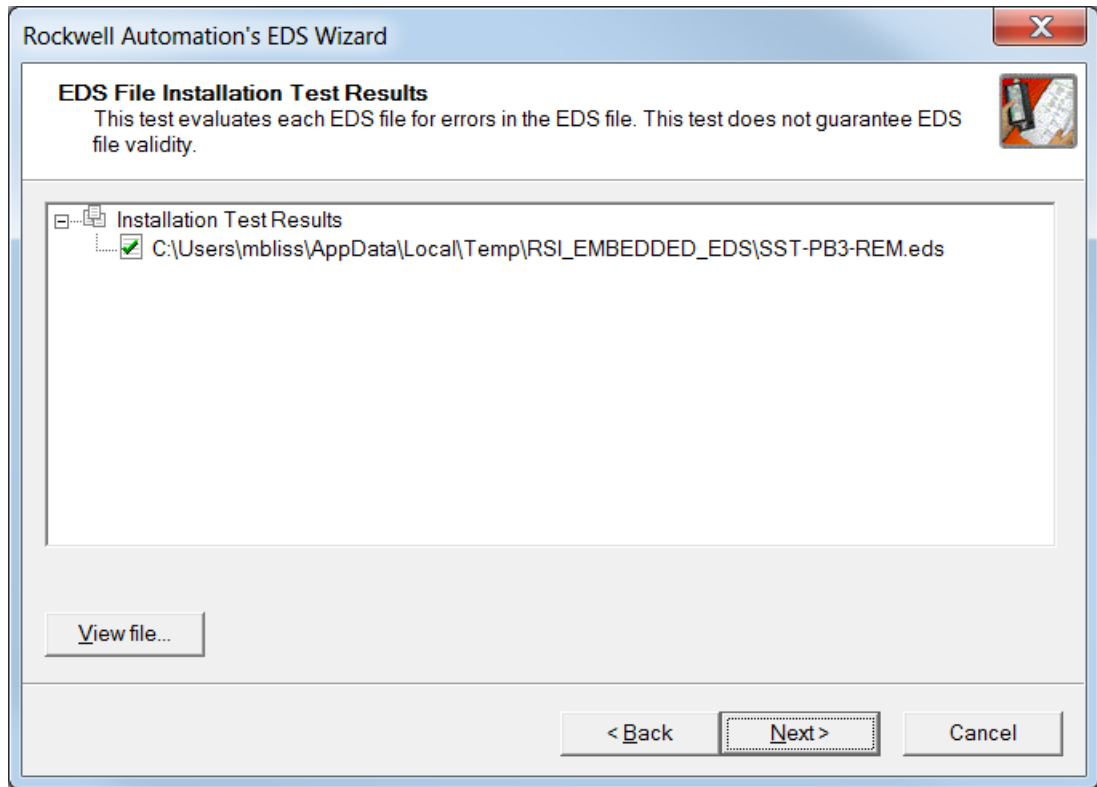

7. Select the Next button.

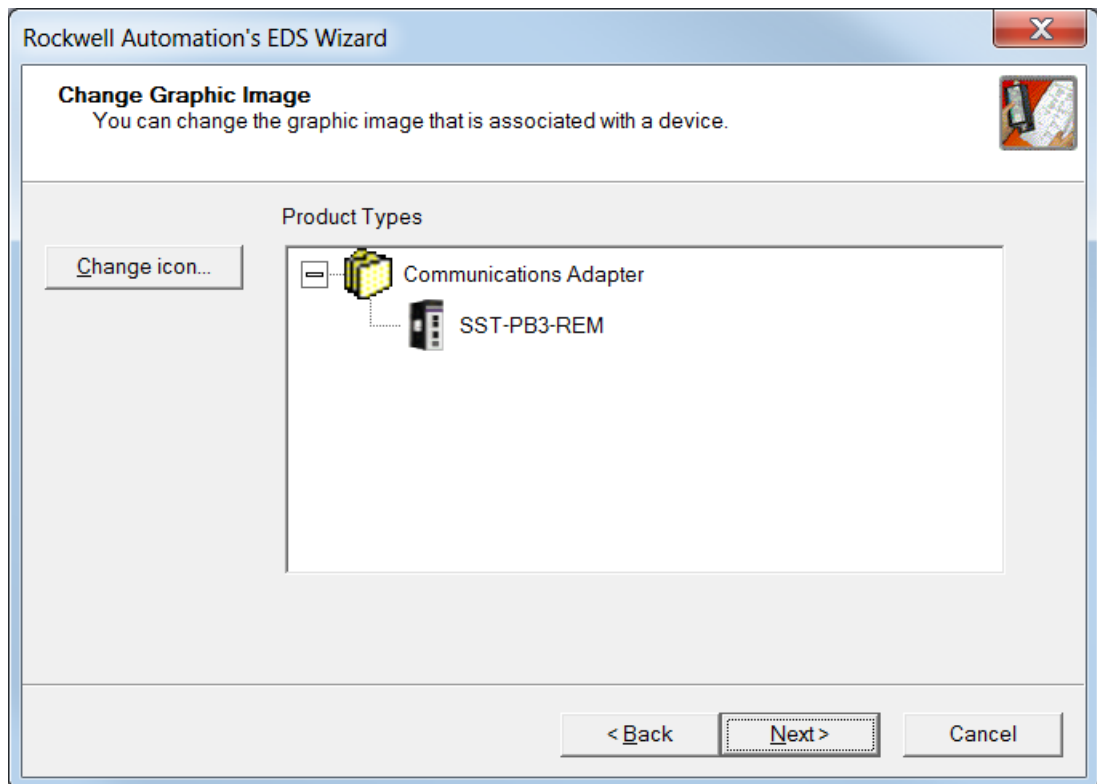

8. Select the Next button.

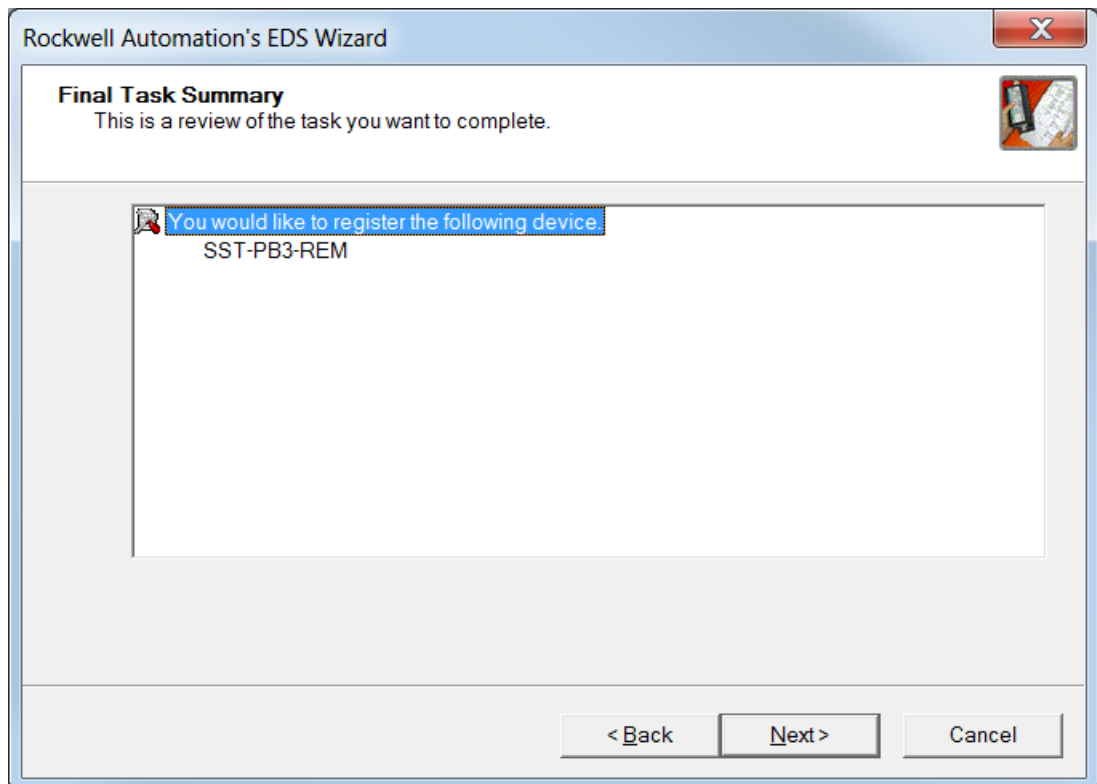

- 9. Select the Next button.

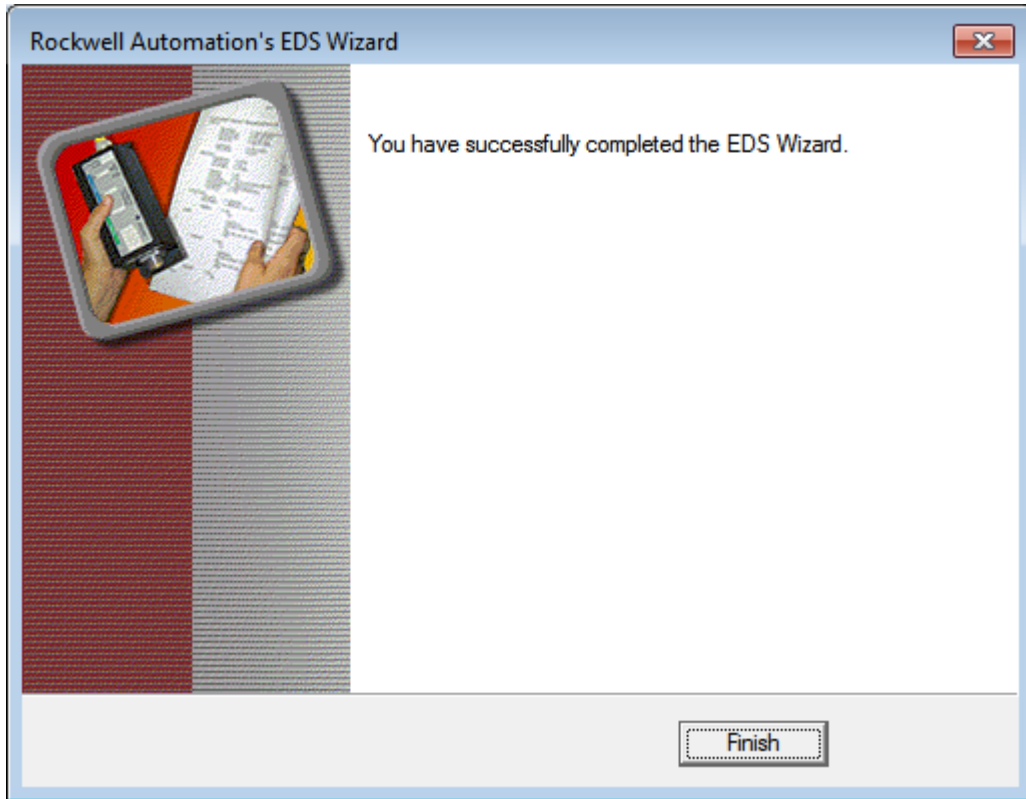

- 10. Select the Finish button.

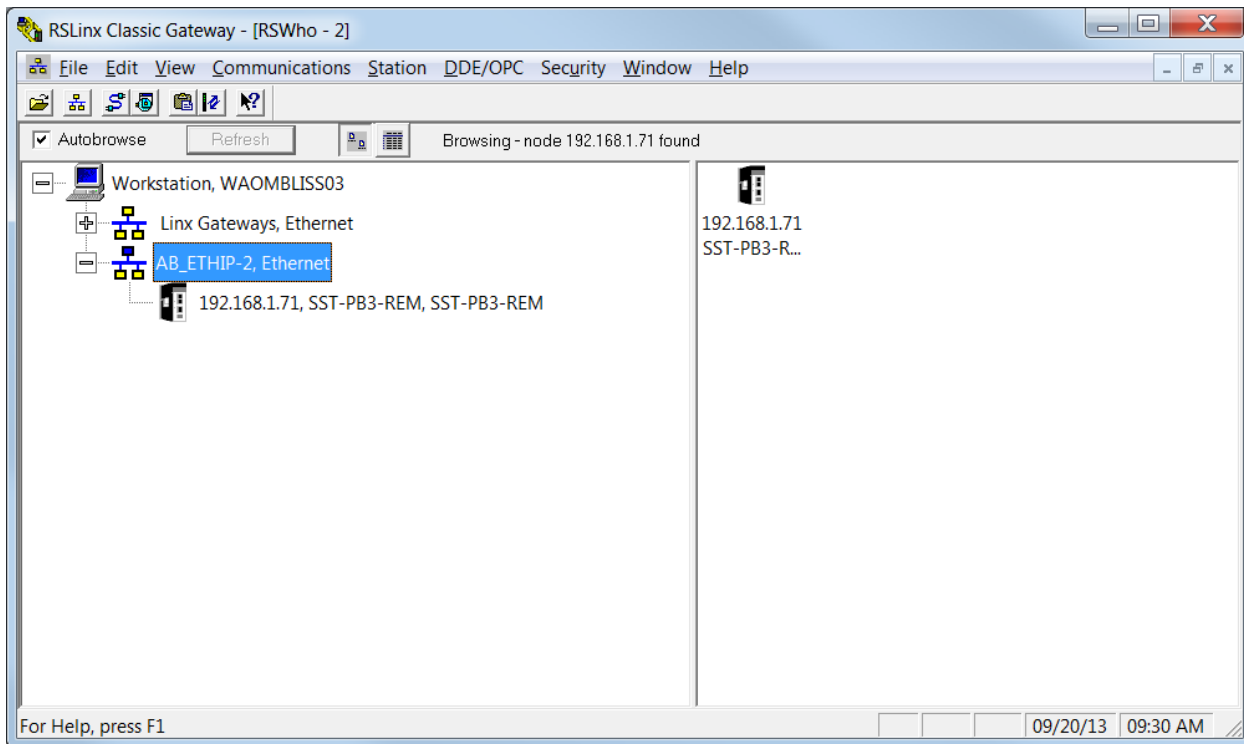

The SST-PB3-REM EDS is now registered. To begin configuring the SST-PB3-REM, see section [6.4](#), Configuring the SST-PB3-REM in Studio 5000 V21 using EDS AOP (Add-On-Profile).

5.3.2 Registering EDS file via EDS Hardware Installation Tool

1. Launch Rockwell's EDS Hardware Installation Tool by going to the start menu and selecting Rockwell Software, RSLinx, Tools and then EDS Hardware Installation Tool as in the screenshot below.

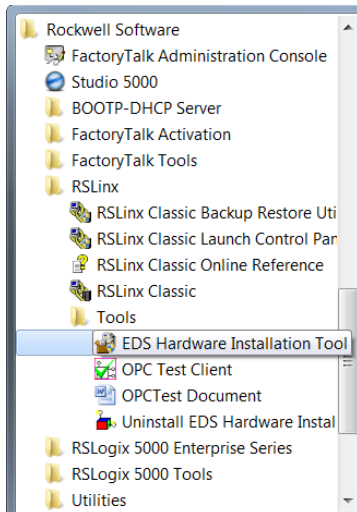

2. Rockwell's EDS Wizard dialog window will appear.



3. Select the Next button.

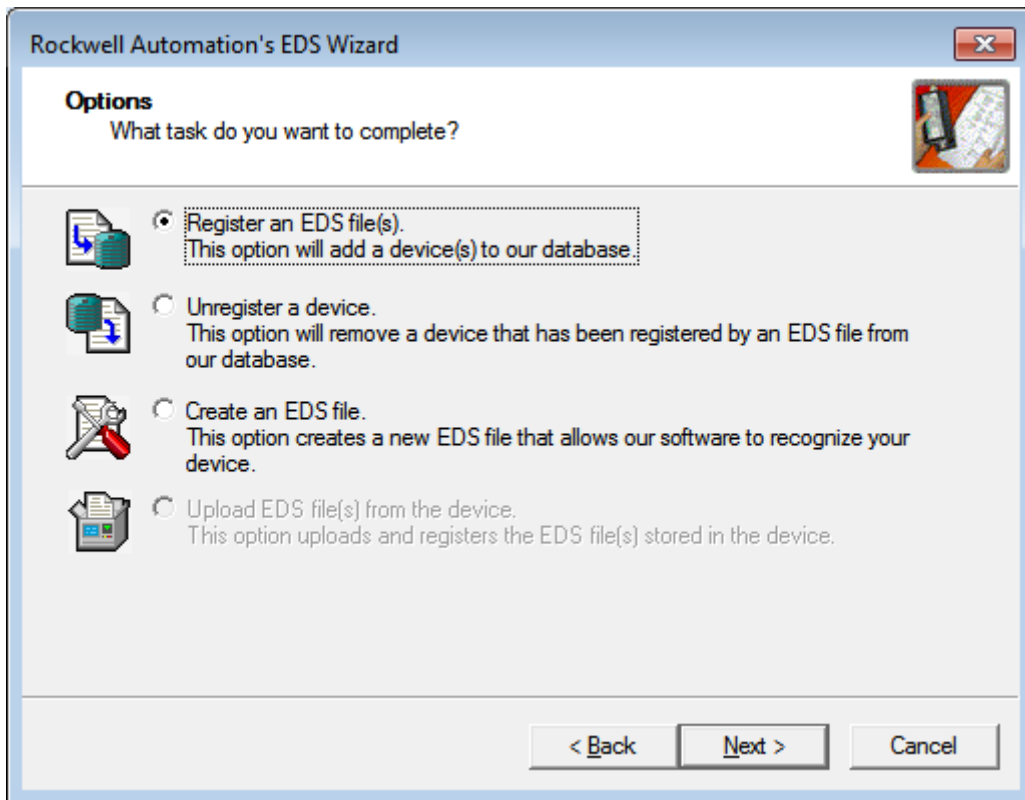

4. Select “**Register an EDS file(s).**” and click on Next button.

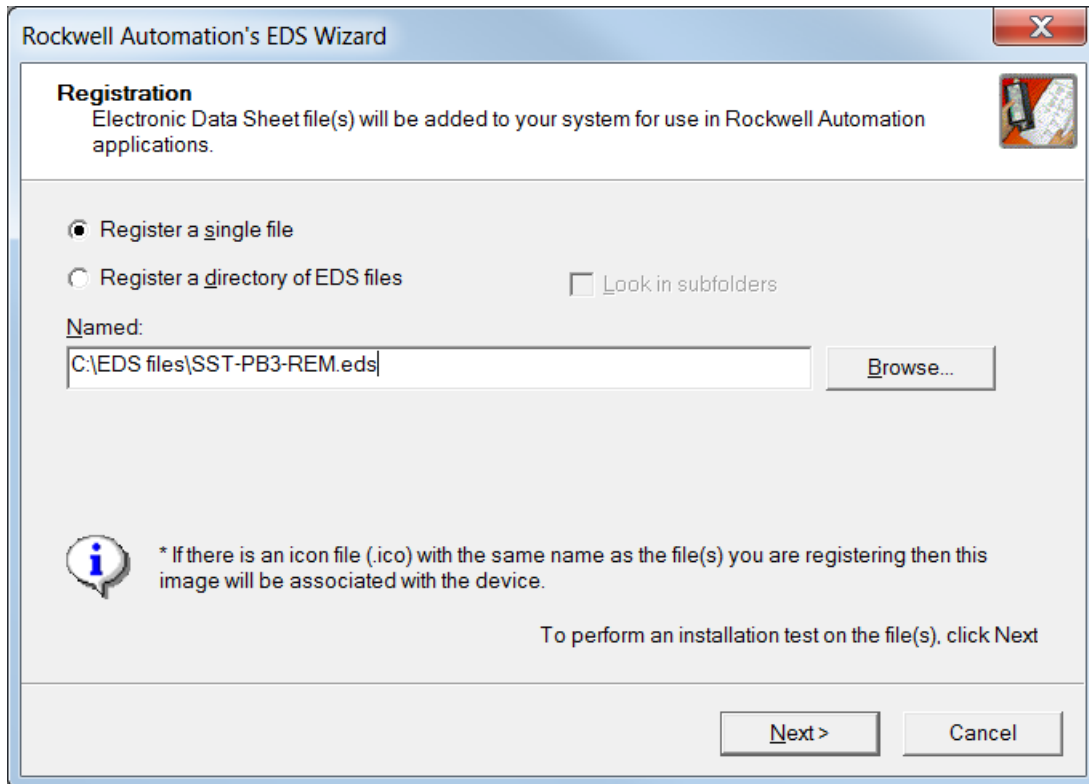

5. Select “**Register a single file**” and select the Next button.

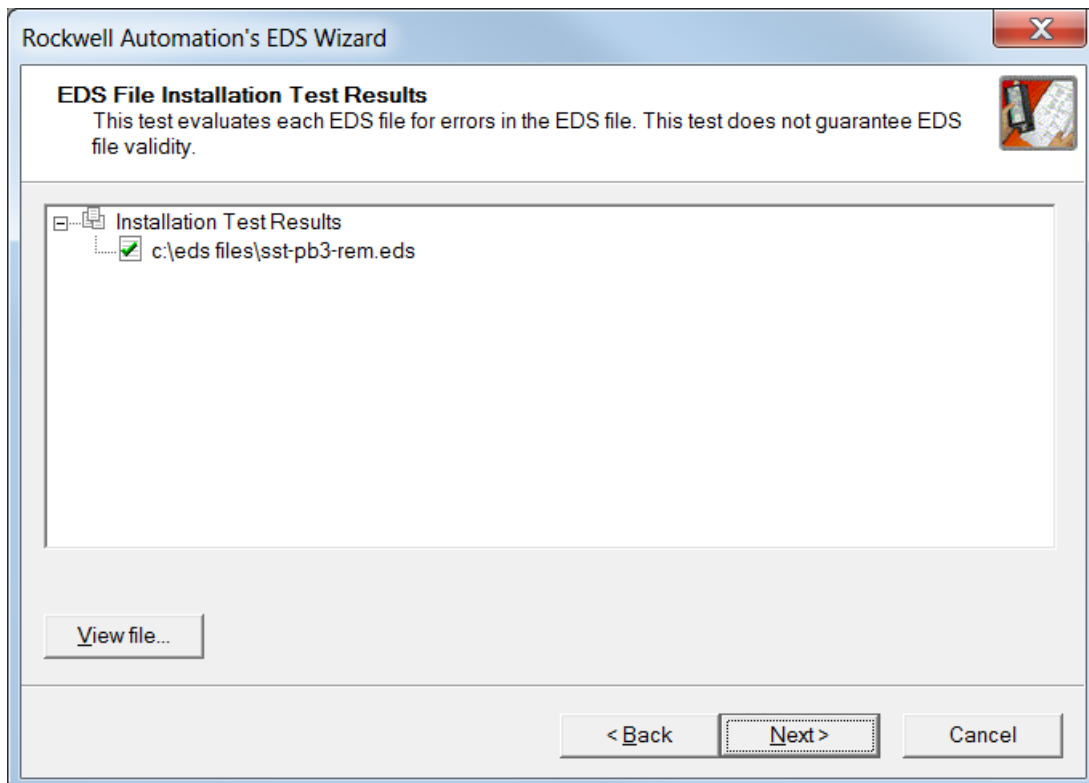

6. Select Next button.

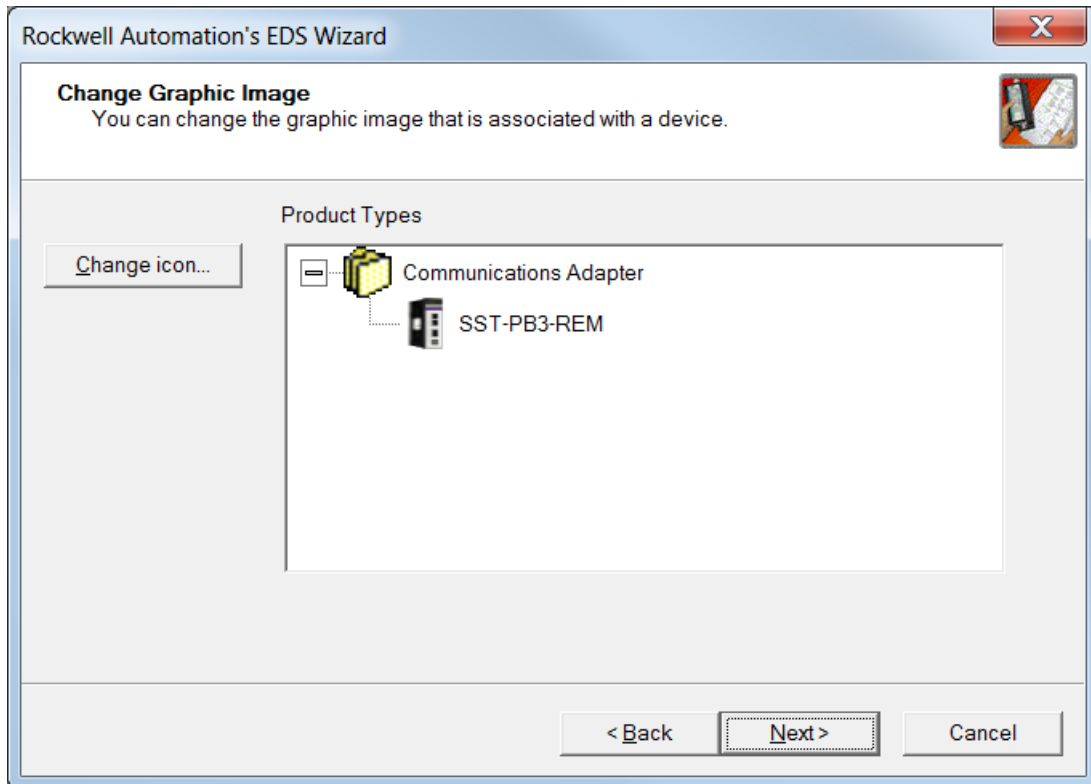

7. Select Next button.

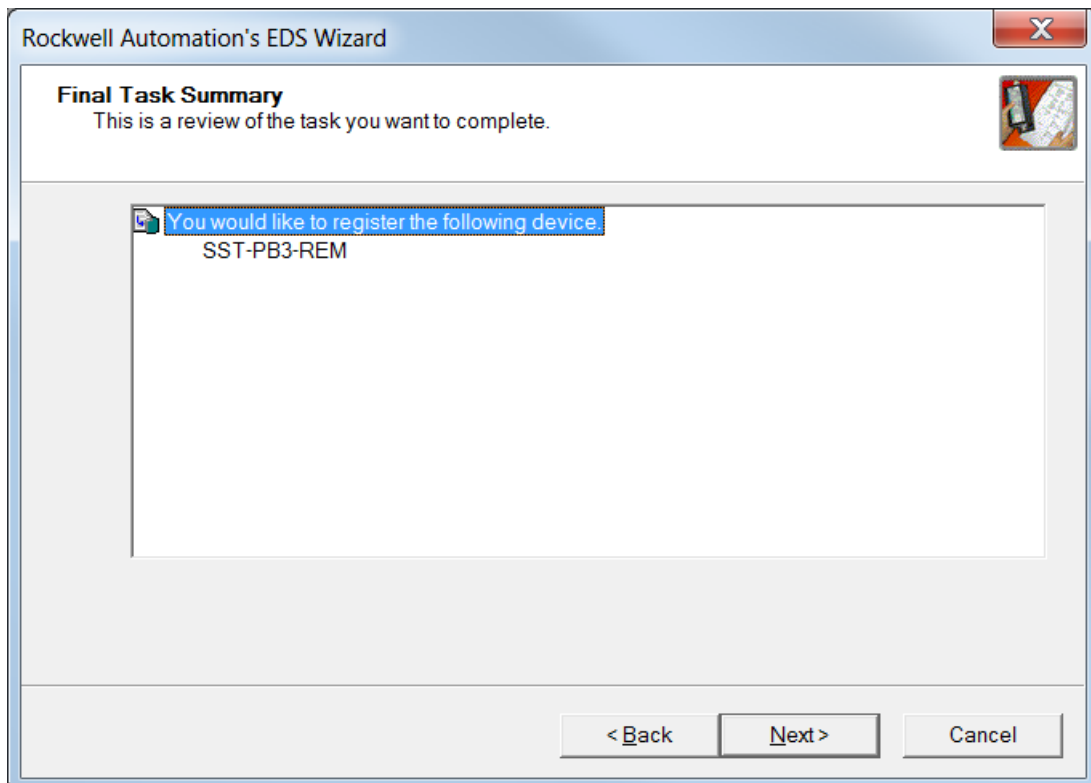

8. Select Next button.

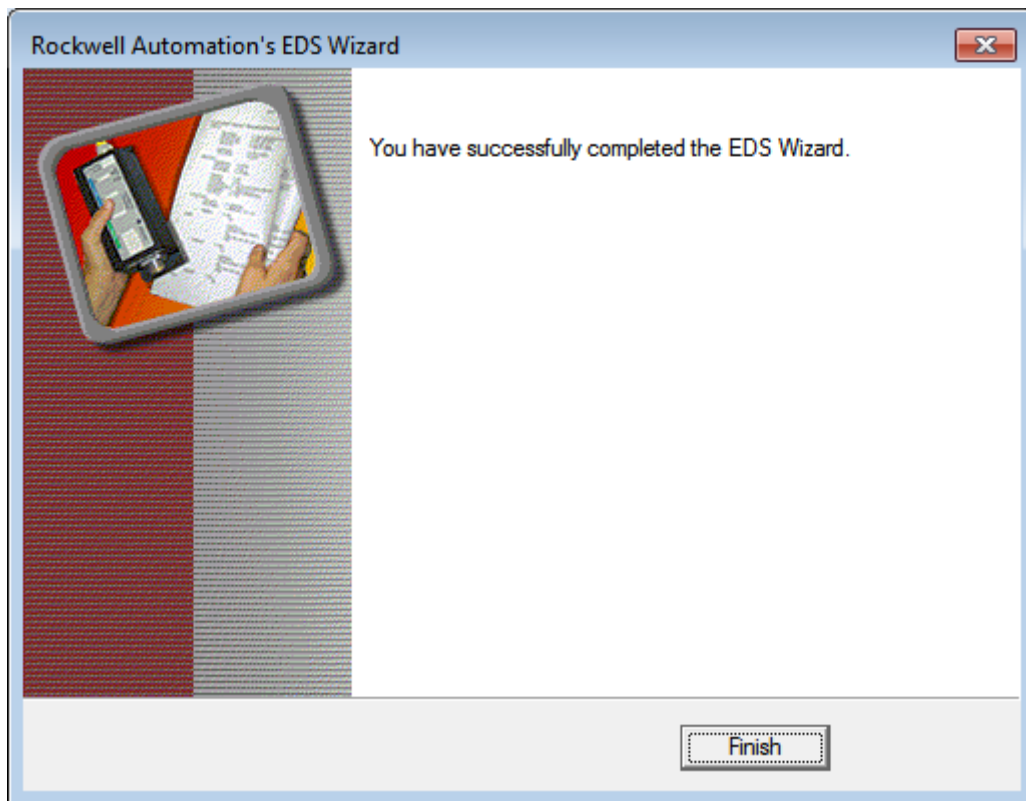

9. Select Finish button

5.4 Changing the Ethernet Port Configuration of the SST-PB3-REM in RSLinx

The EDS file must be registered before the Ethernet port configuration can be changed.

1. Select the SST-PB3-REM that appears in RSLinx as below.

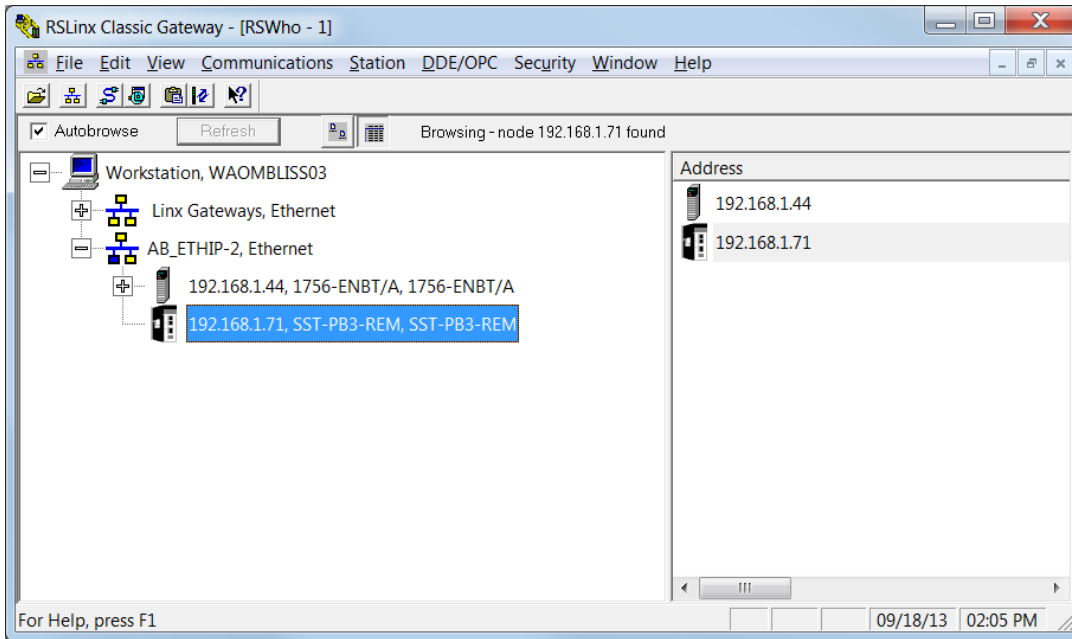

2. Right-Click on the SST-PB3-REM appears under the Ethernet/IP Driver as below.

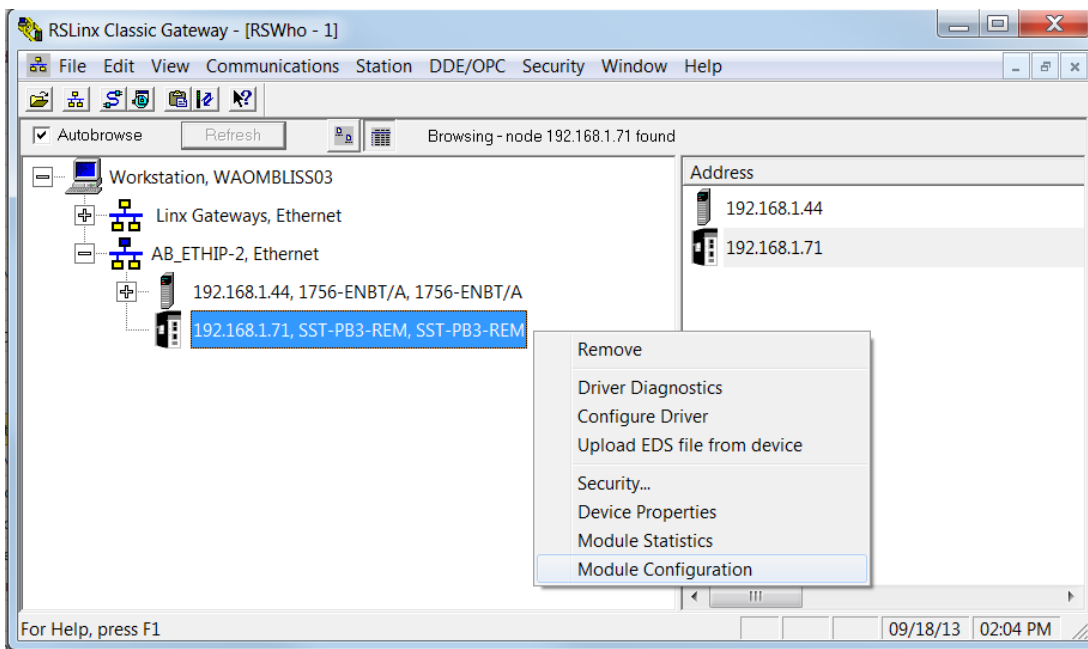

3. Select Module Configuration. If this option does not appear do the following:

- a. Register the latest EDS file v2.1 or higher by using the “Upload EDS file from device” option.
 - b. Shutdown RSLinx and restart it.
4. The following screen should appear.

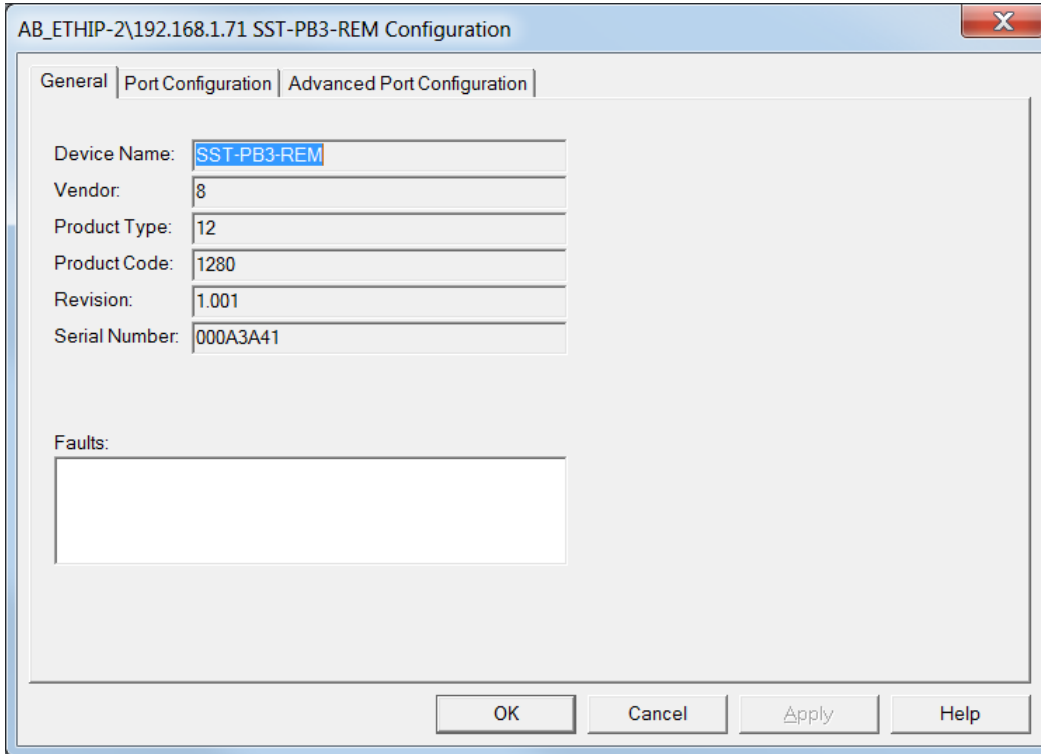

5. Select the Port Configuration tab.

The screenshot shows a configuration window titled "AB_ETHIP-2\192.168.1.71 SST-PB3-REM Configuration". It has three tabs: "General", "Port Configuration" (which is selected), and "Advanced Port Configuration".

Under the "Port Configuration" tab, there is a section for "Network Configuration Type" with two radio buttons: "Static" (selected) and "Dynamic". Below this are two options: "Use DHCP to obtain network configuration." (unselected) and "Use BOOTP to obtain network configuration." (selected).

The following fields are visible:

- IP Address: 192 . 168 . 1 . 71
- Network Mask: 255 . 255 . 255 . 0
- Gateway Address: 0 . 0 . 0 . 0
- Primary Name Server: 0 . 0 . 0 . 0
- Secondary Name Server: 0 . 0 . 0 . 0
- Domain Name: (empty text box)
- Host Name: (empty text box)
- Status: Network Interface Configured

At the bottom of the window are four buttons: "OK", "Cancel", "Apply", and "Help".

6. Enter the new Port settings and select Apply. The new port settings will not take effect until the module is reset or power has been cycled.

5.5 Configuring the SST-PB3-REM in Studio 5000 V21 using EDS AOP (Add-On-Profile)



Note

To use the EDS AOP for the SST-PB3-REM Remote Module, Studio 5000 Version 21 or higher is required.

1. Under the Ethernet/IP module as below highlight **Ethernet** and select **New Module...**

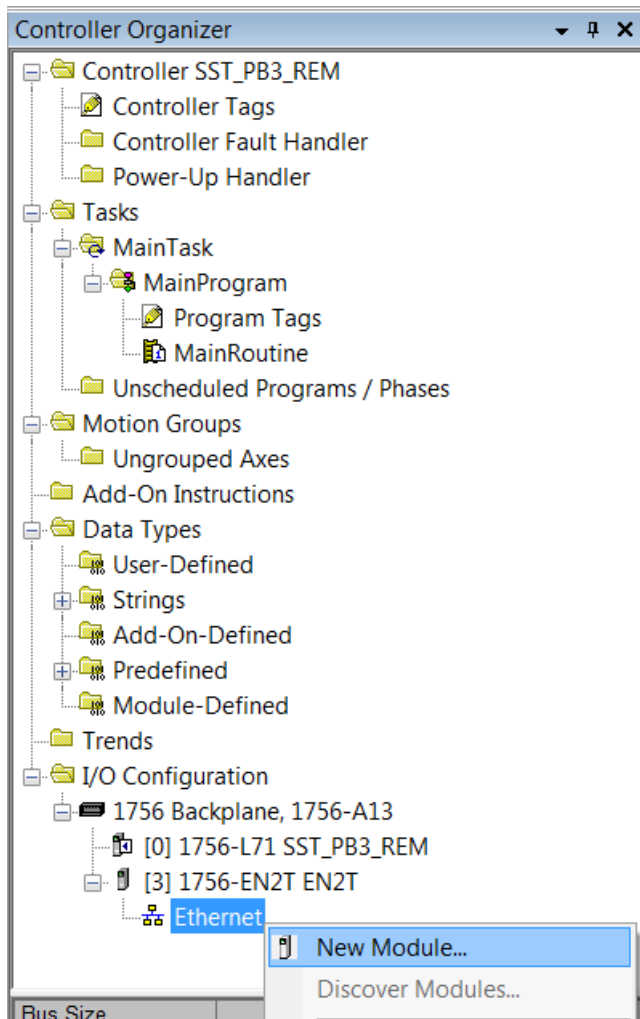

2. Select SST-PB3-REM from the Catalog below.

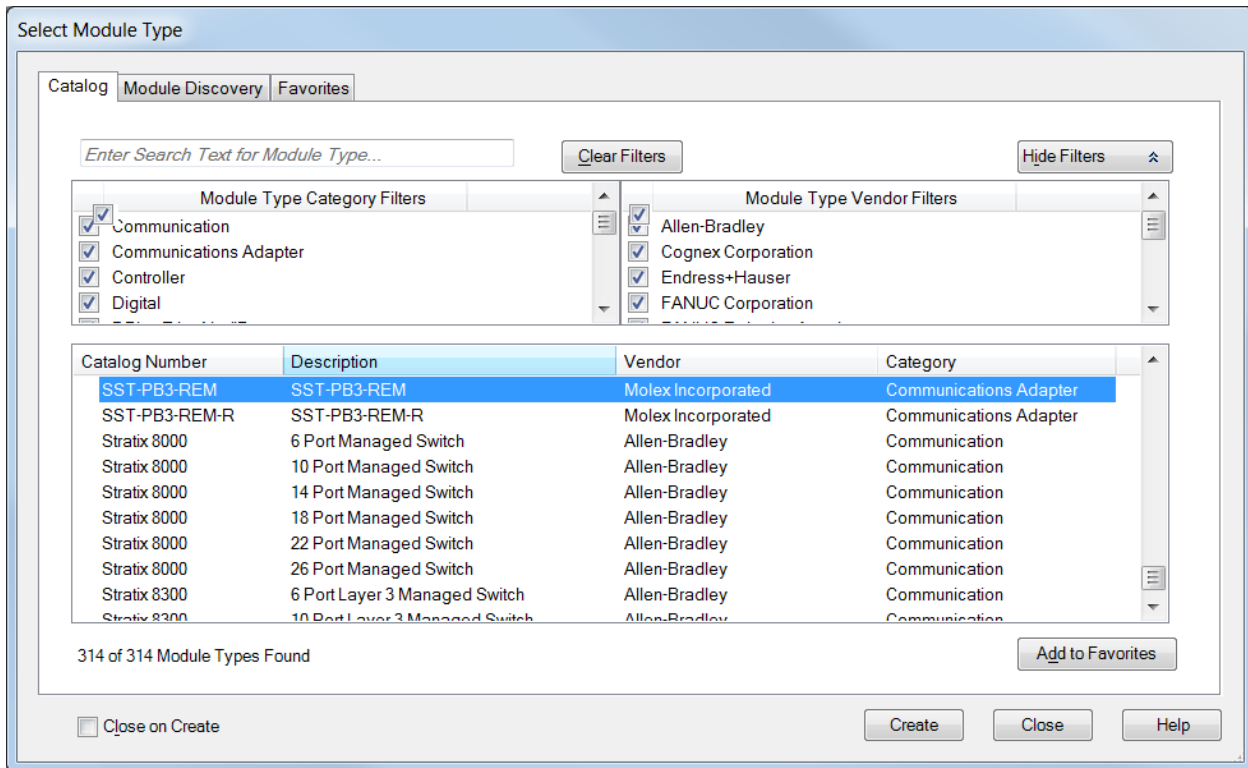

3. Select Create Button
4. The New Module dialog window is displayed.

New Module

General | Connection | Module Info | Configuration | Internet Protocol | Port Configuration

Type: SST-PB3-REM SST-PB3-REM
Vendor: Molex Incorporated
Parent: EN2T
Name:
Description:

Ethernet Address
 Private Netwc 192.168.1
 IP Address:
 Host Name:

Module Definition
Revision: 1.1
Electronic Keying: Compatible Module
Connections: 1st Exclusive Owner

Status: Creating

5. Enter a Name for module and enter the IP address of the SST-PB3-REM module.

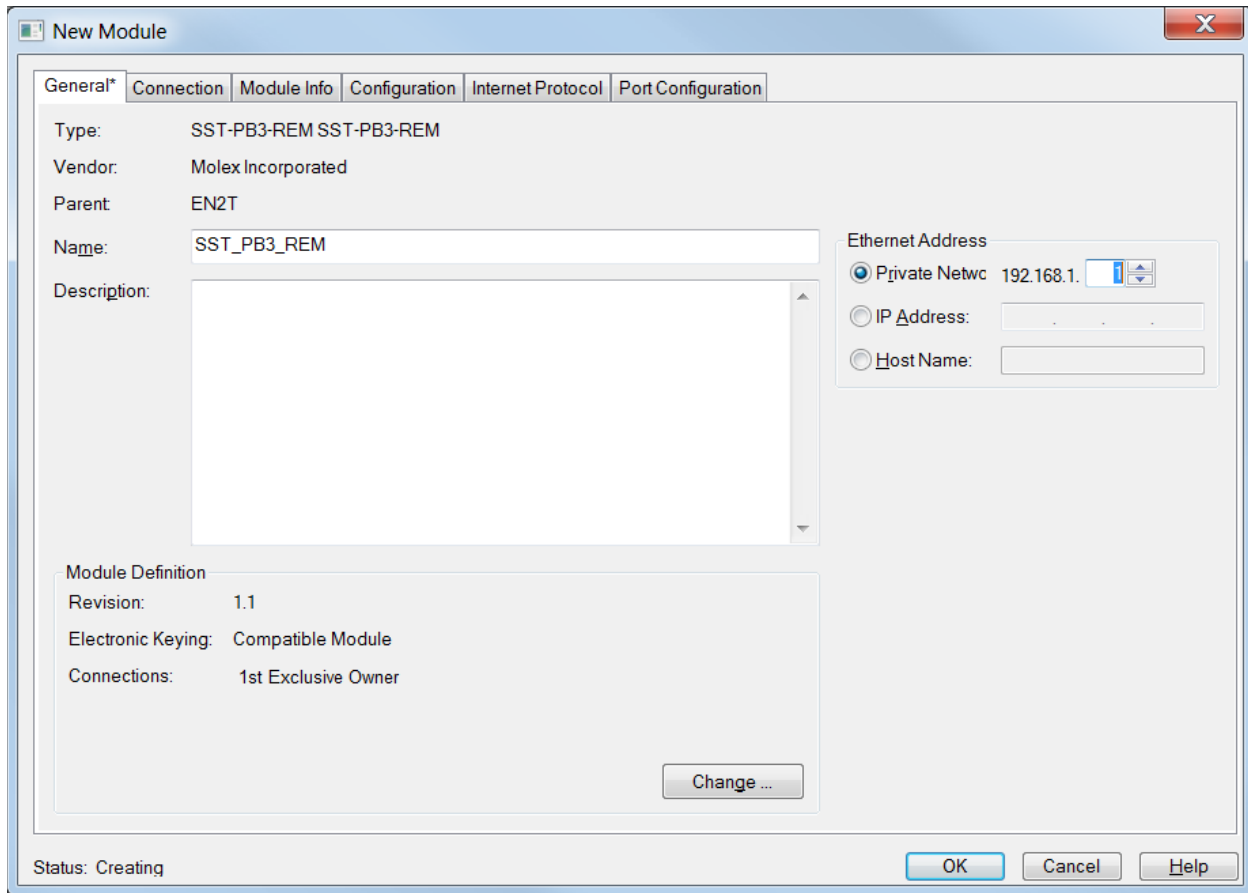

6. Select the **Change button...** to add more Exclusive Owner connections. By default, the SST-PB3-REM is preconfigured with one Exclusive Owner connection. If configuring a DP Master only proceed to the following section. For configuring as DP Slave only see section [5.5.2](#), Configuring Remote Module as DP Slave Only via EDS AOP. For configuring Remote Module as Master and Slave via EDS AOP, see section [5.5.3](#).

5.5.1 Configuring Remote Module as DP Master only via EDS AOP

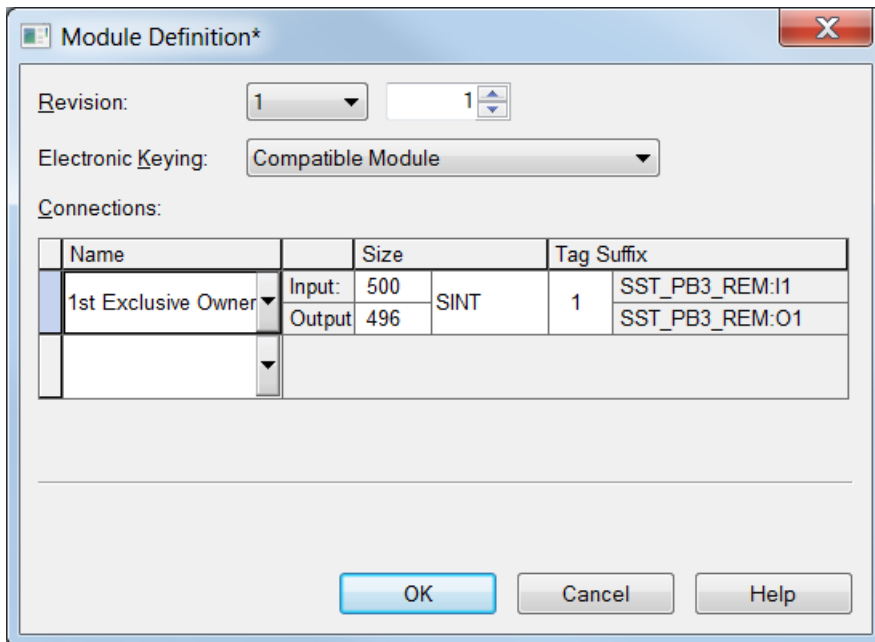

1. Select the drop-down arrow under 1st Exclusive Owner to add more Exclusive owner connections. Up to 5 exclusive owner connections can be configured. If you require status information add the Status – Input Only connection. When the SST-PB3-REM is configured as a Profibus Master, the 1st Exclusive Owner connection must always be for the first connection configured as below.
2. Next add the Status – Input Only connection.

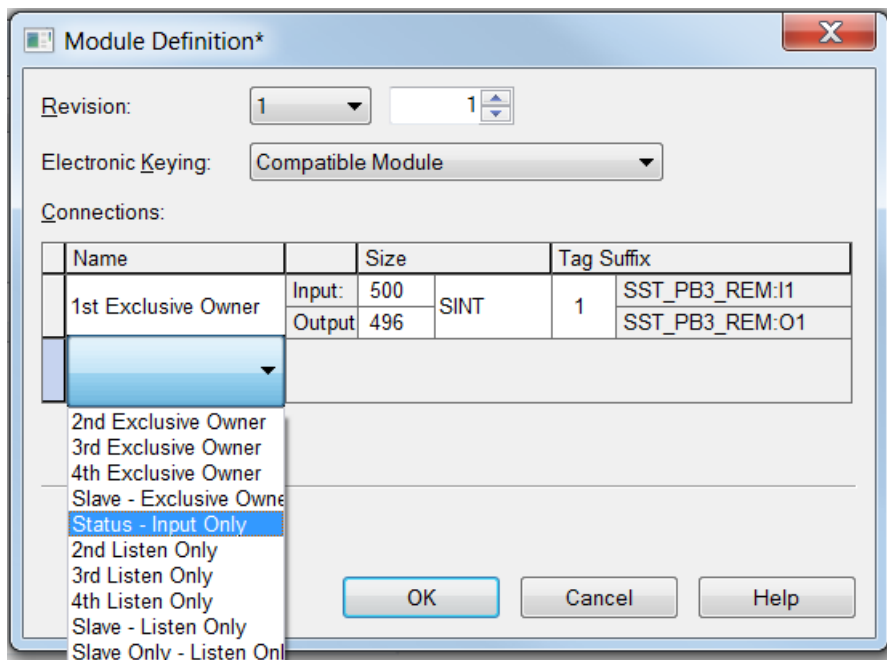

- Next add the Status – Input Only connection.

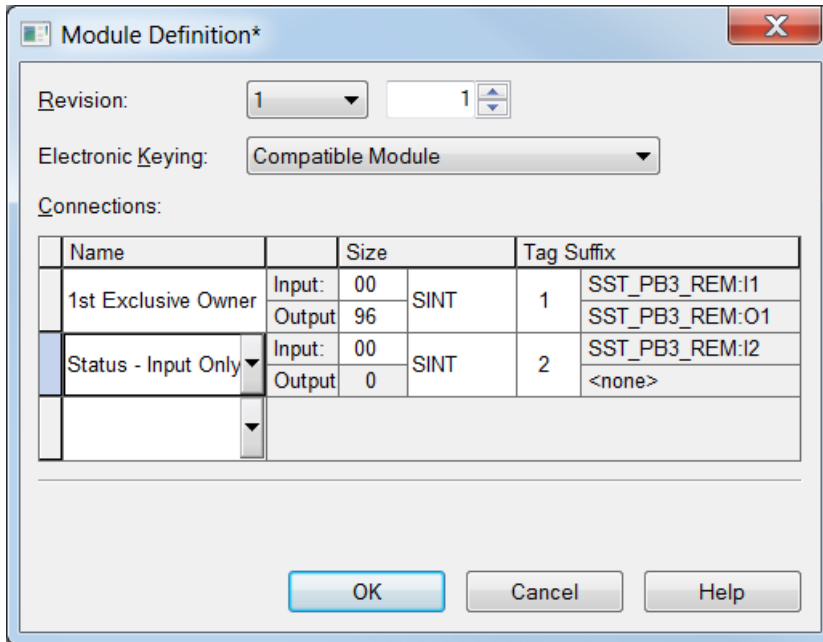

- The status – Input Only connection is now added.
- Now go to the configuration tab.

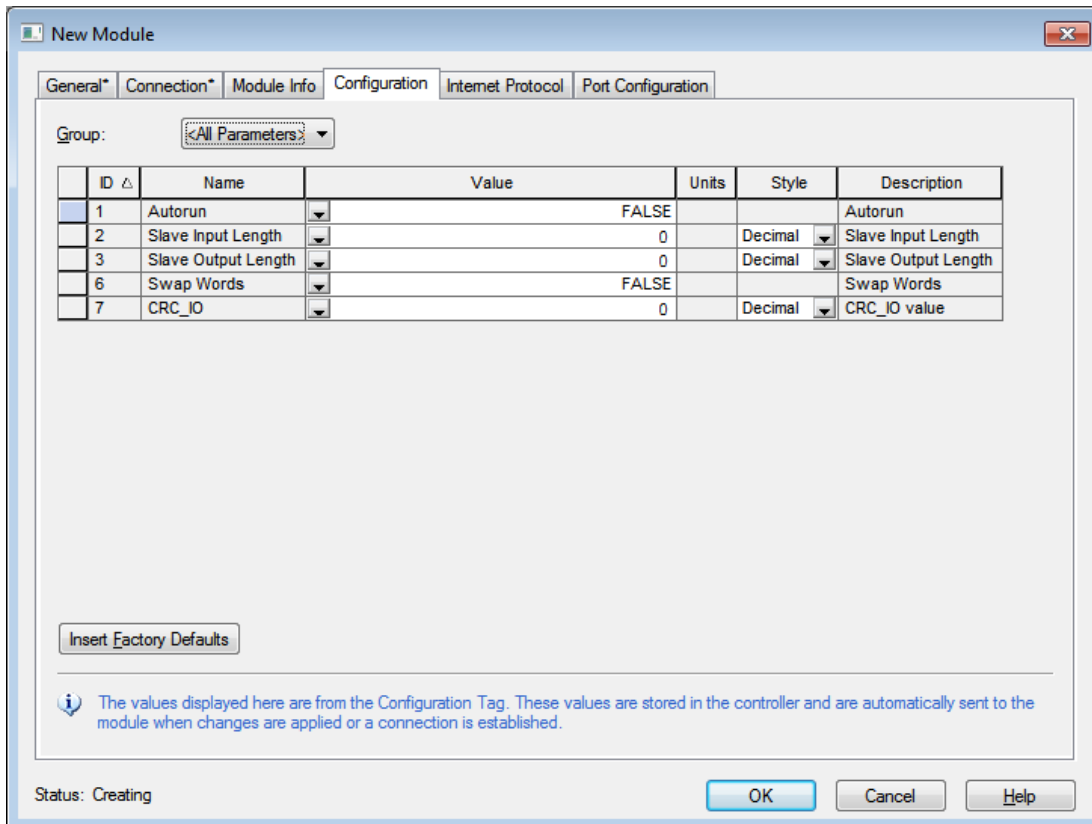

- Configure the AutoRun option to TRUE if the Remote module is required to go online automatically and enter RUN mode when PLC enters RUN mode
- Configure CRC_IO to make sure connection to the Remote is only possible with the Profibus configuration that contains this CRC_IO. The CRC_IO is obtained from the SST Profibus Configuration tool under Master Properties/ Parameters tab. See highlighted I/O CRC in example below.

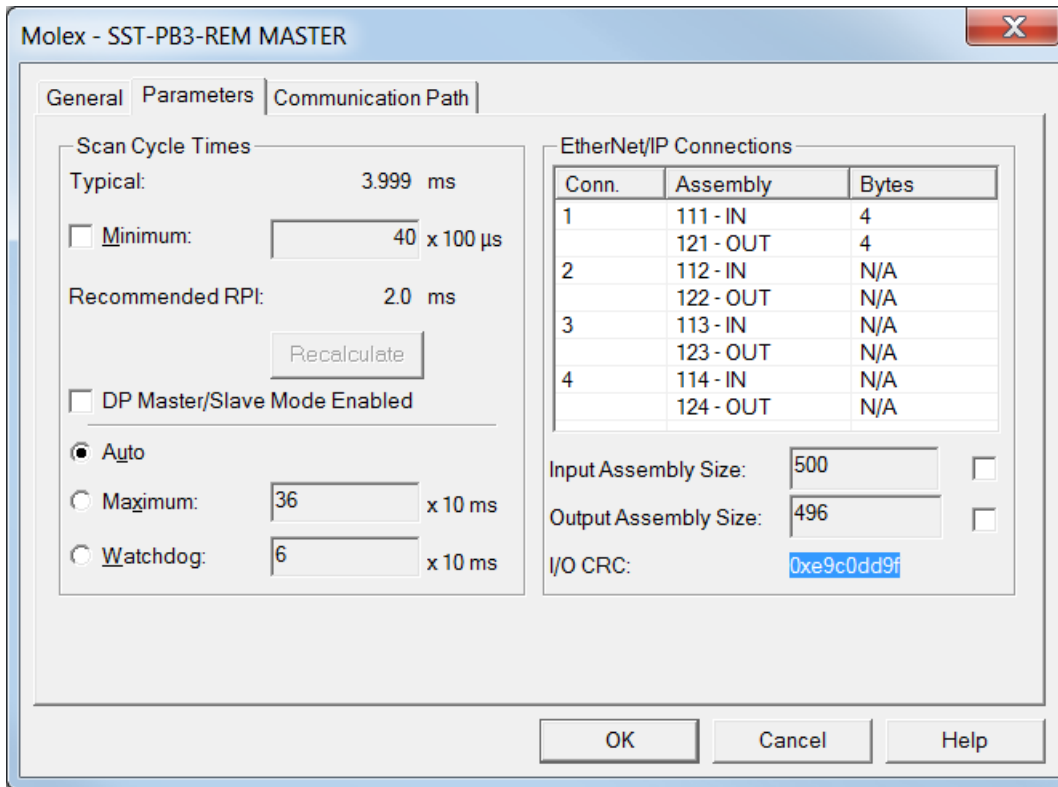

8. See Section [5.5.4](#) Configuring the RPIs for all configured connections to configure RPIs for all connections.

5.5.2 Configuring Remote module as Slave only via EDS AOP

1. After clicking on the Change button on the General Properties, remove the default 1st Exclusive Owner connection by right-clicking on left side of connection name and selecting delete from mouse menu.
2. Add “Slave Only- Excusive Owner” Connection as below.

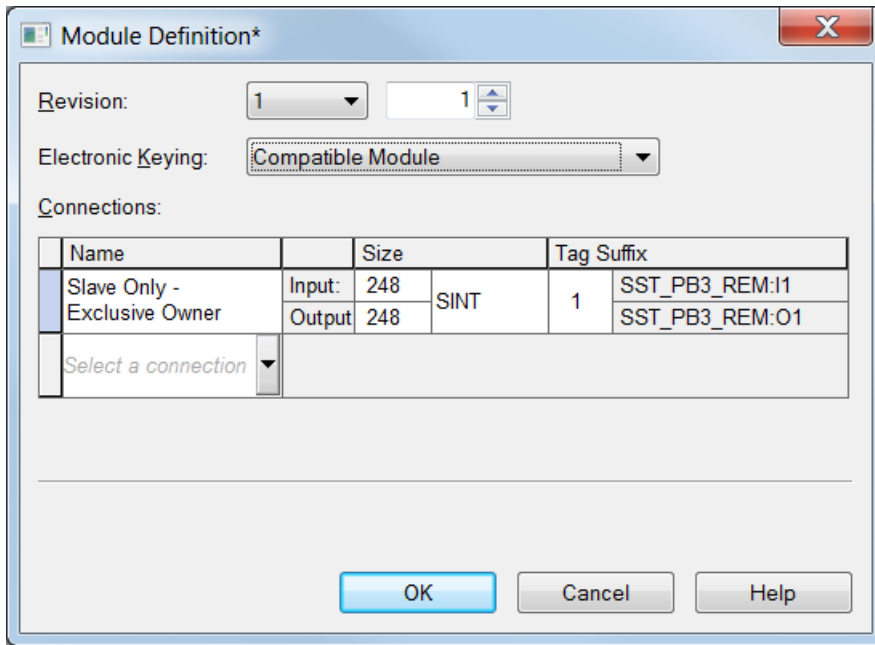

3. Add “Slave Only Status – Input Only” if status information is required.

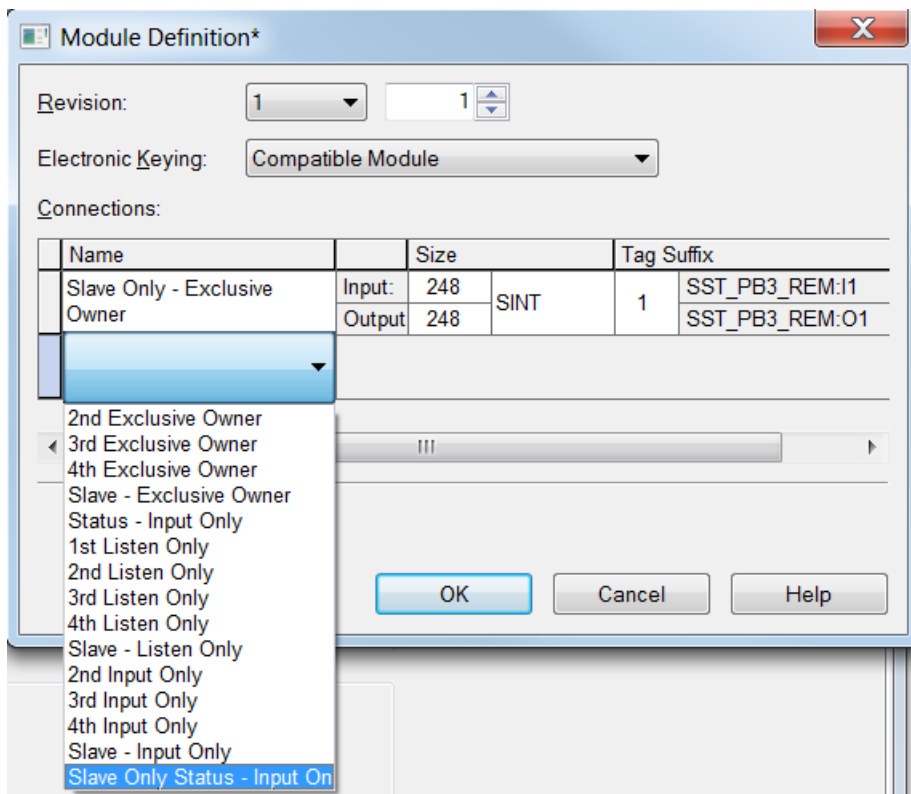

4. Click on OK button.

New Module

General* | Connection* | Module Info* | Configuration* | Internet Protocol* | Port Configuration*

Type: SST-PB3-REM-R SST-PB3-REM-R
Vendor: Molex Incorporated
Parent: ENBT
Name: SST_PB3_REM_R
Description:

Ethernet Address
 Private Network: 192.168.1. 1
 IP Address:
 Host Name:

Module Definition
Revision: 1.1
Electronic Keying: Compatible Module
Connections: Slave Only - Exclusive Owner
Slave Only Status - Input Only

Change ...

Status: Creating

OK Cancel Help

5. Click on Configuration tab to configure the slave parameters.

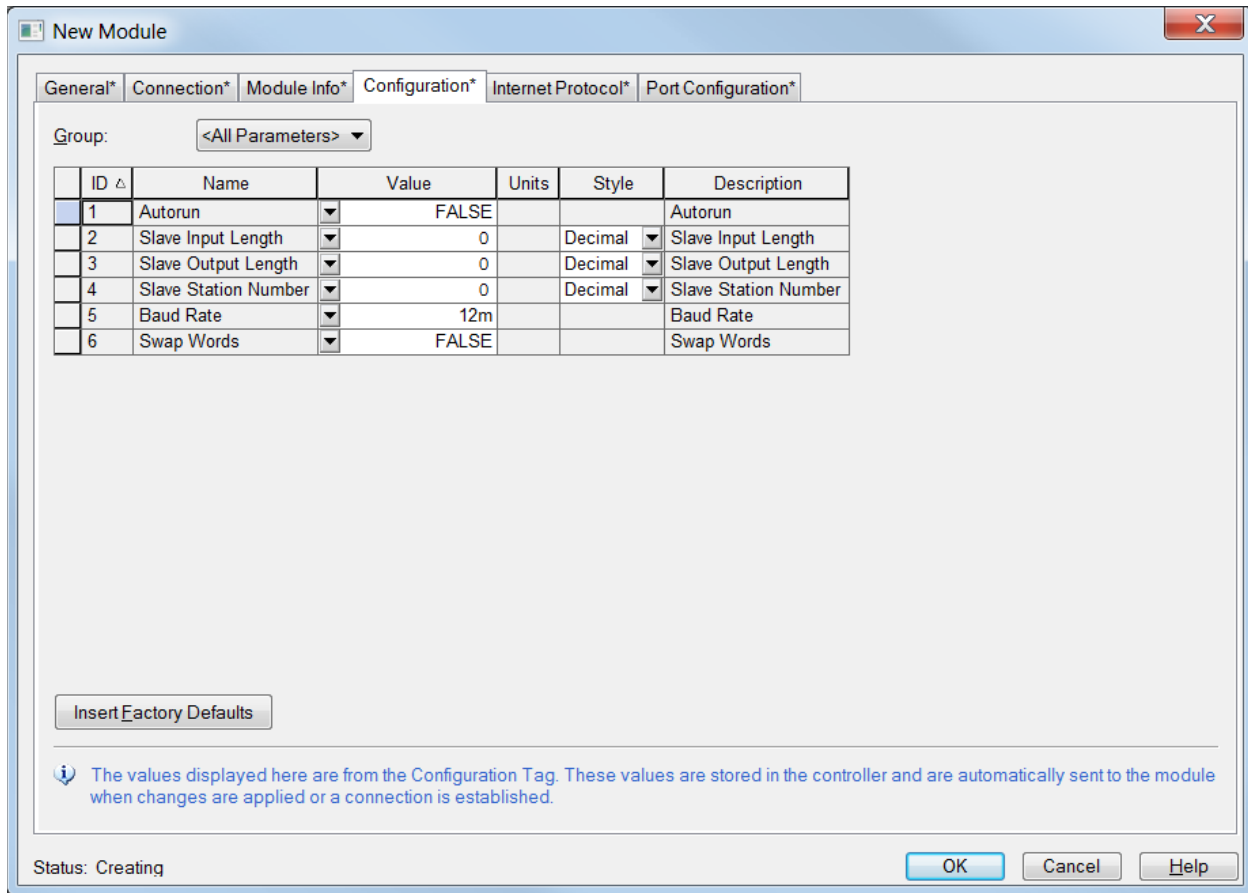

6. Set the above parameters as follows by selecting the cell under Value column:
 - a. Set Aautorun to TRUE if the module is to go online and into RUN when connection is made to module with PLC in RUN mode.
 - b. Set the Slave Input Length to value between 0 – 244 bytes
 - c. Set the Slave Output Length to a value between 0 – 244 bytes.
 - d. Set the Slave Station Number to a value between 0 – 125
 - e. Set baud rate between 9k6 to 12MB inclusive.
7. Click Ok button when complete.

5.5.3 Configuring the Remote Module as Master and Slave via EDS AOP

1. After clicking on the Change button on the New Module Dialog (General tab), configure the required EO connections for Profibus Master and then configure the Slave – Exclusive Owner connection (Last connection).

The example below shows the SST-PB3-REM configured with 4 EO connections and the Slave Exclusive Owner connection

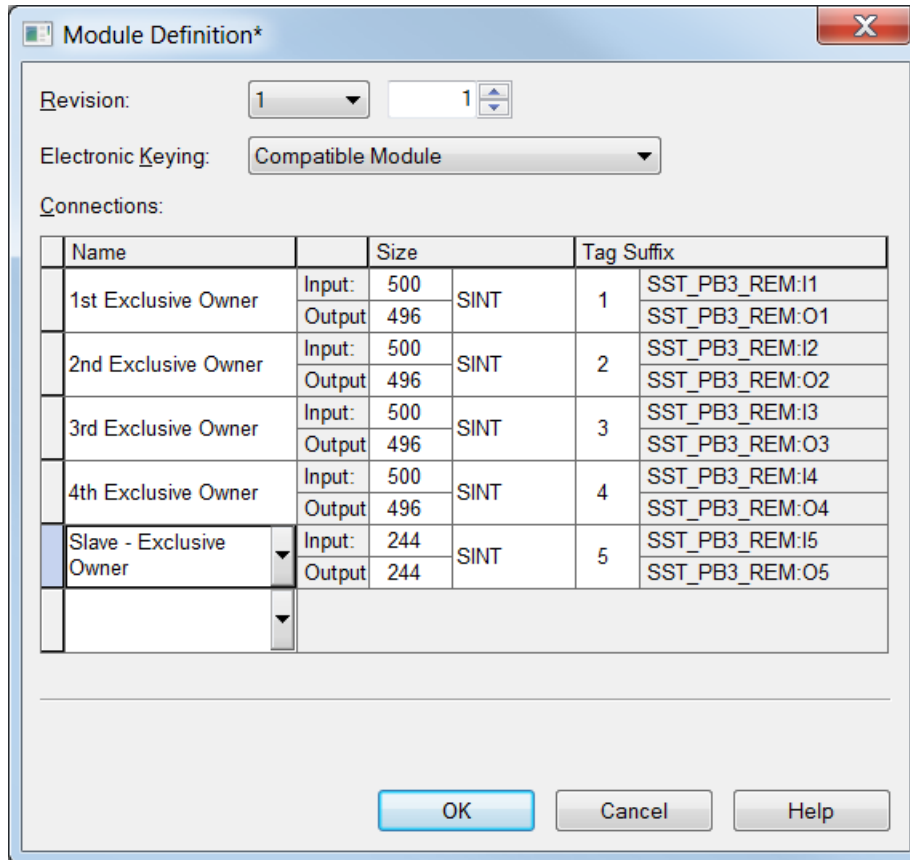

- Click OK button to return to the New Module dialog and select the Connection tab.

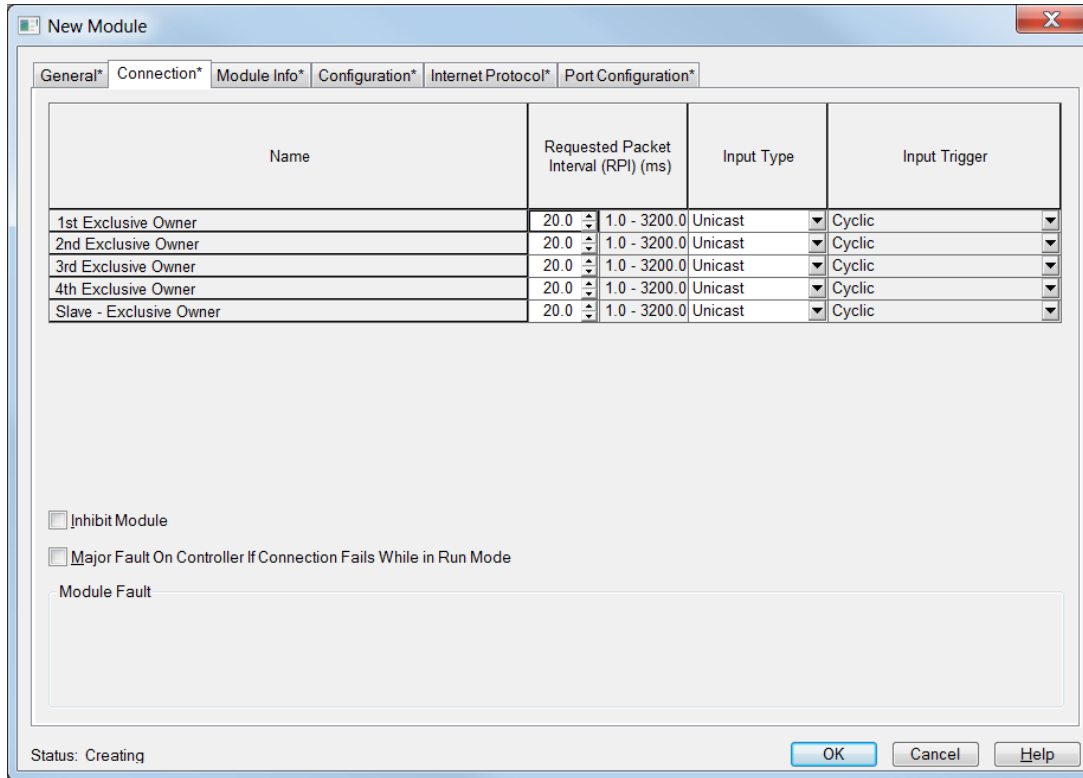

3. Configure the RPIs for all connections. These should match the recommended RPIs from your Profibus configuration in the SST Profibus ConfigurationTool. Below is example of a Profibus Master and Slave configuration.

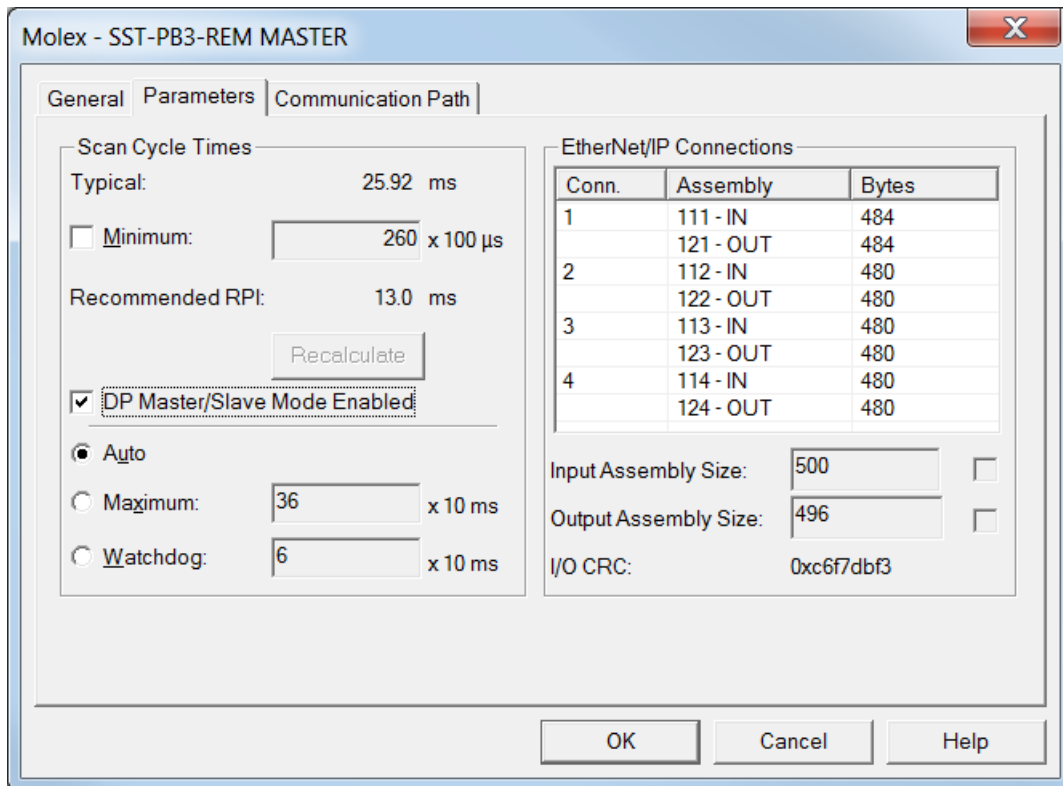

4. Confirm **DP Master/Slave Mode Enabled** is enabled as above since this adjusts the Recommended RPI.
5. Click on the Configuration tab.

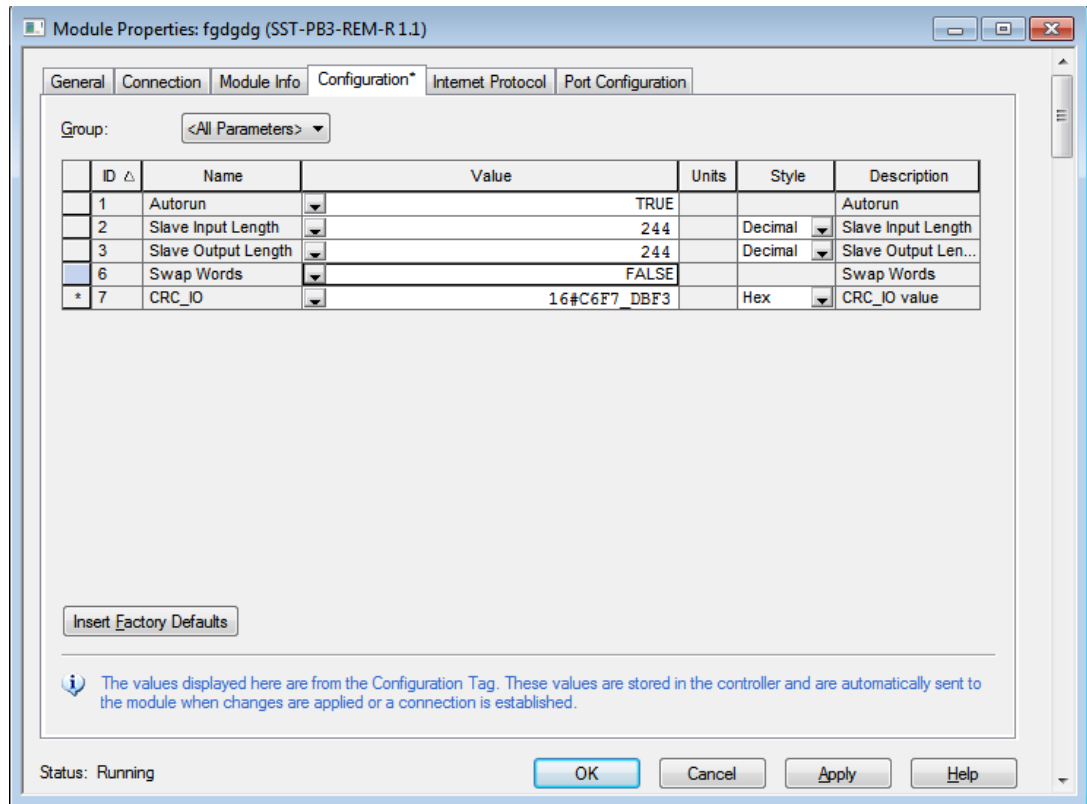

6. Set the above parameters as follows by selecting the cell under Value column:
 - a. Set Autorun to TRUE if the module is to go online and into RUN when connection is made to module with PLC in RUN mode.
 - b. Set the Slave Input Length to value between 0 – 244 bytes
 - c. Set the Slave Output Length to a value between 0 – 244 bytes.
 - d. Set the Swap Words if required.
 - e. Set the CRC_IO if required. This value can be found in the Profibus configuration under Master Properties on the Parameters tab where it displays I/O CRC in bottom right corner.



Note

When the SST-PB3-REM is configured as a Master and Slave, the SST-PB3-REM will use the Master Station address and the Master configured baud rate settings for the slave operation.

5.5.4 Configuring the RPIs for all configured connections

After configuring all the required connections, select the connection tab to configure the RPI for each connection. This RPI must match the recommended RPI for the active Profibus configuration on module. The recommended RPI is displayed in the SST Profibus Configuration Tool under the Master Properties/ Parameters tab. Setting the RPI too low will result in losing connection to the controller. In the example below the RPI is changed to 5ms and Input type is changed from Unicast to Multicast.

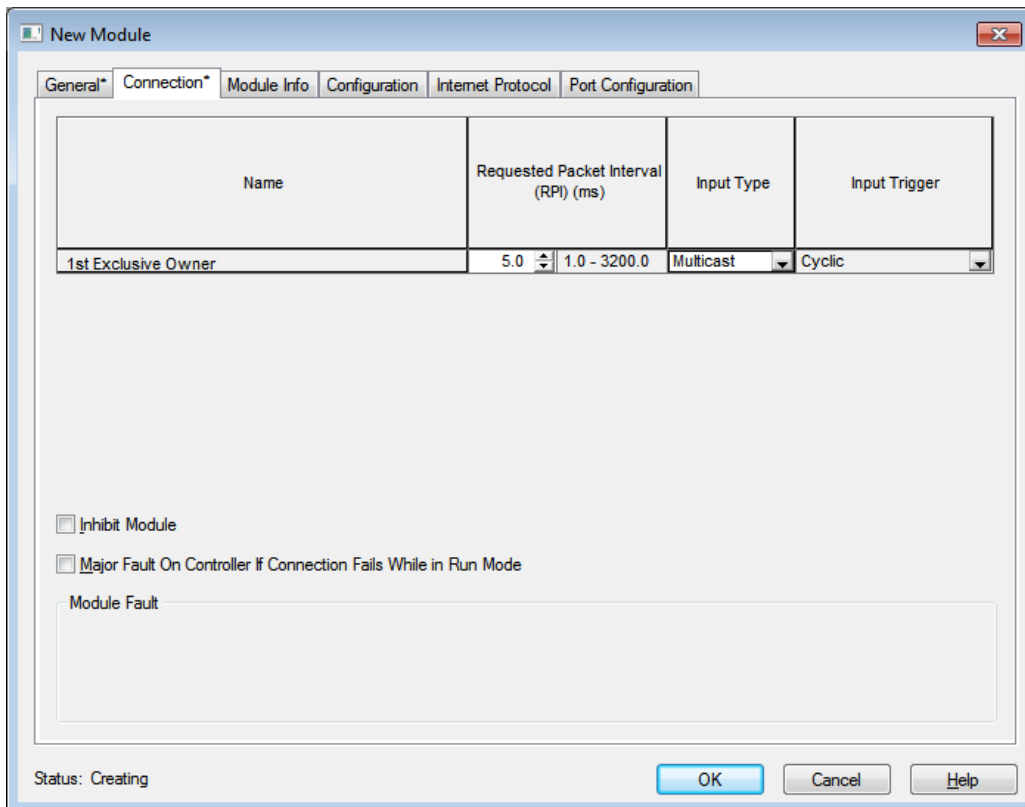

5.5.5 Selecting the Module Info Tab

1. Selecting the Module Info tab brings up the following Dialog and is most useful when online with Controller.

This Dialog will display Identification information, status and configuration status.

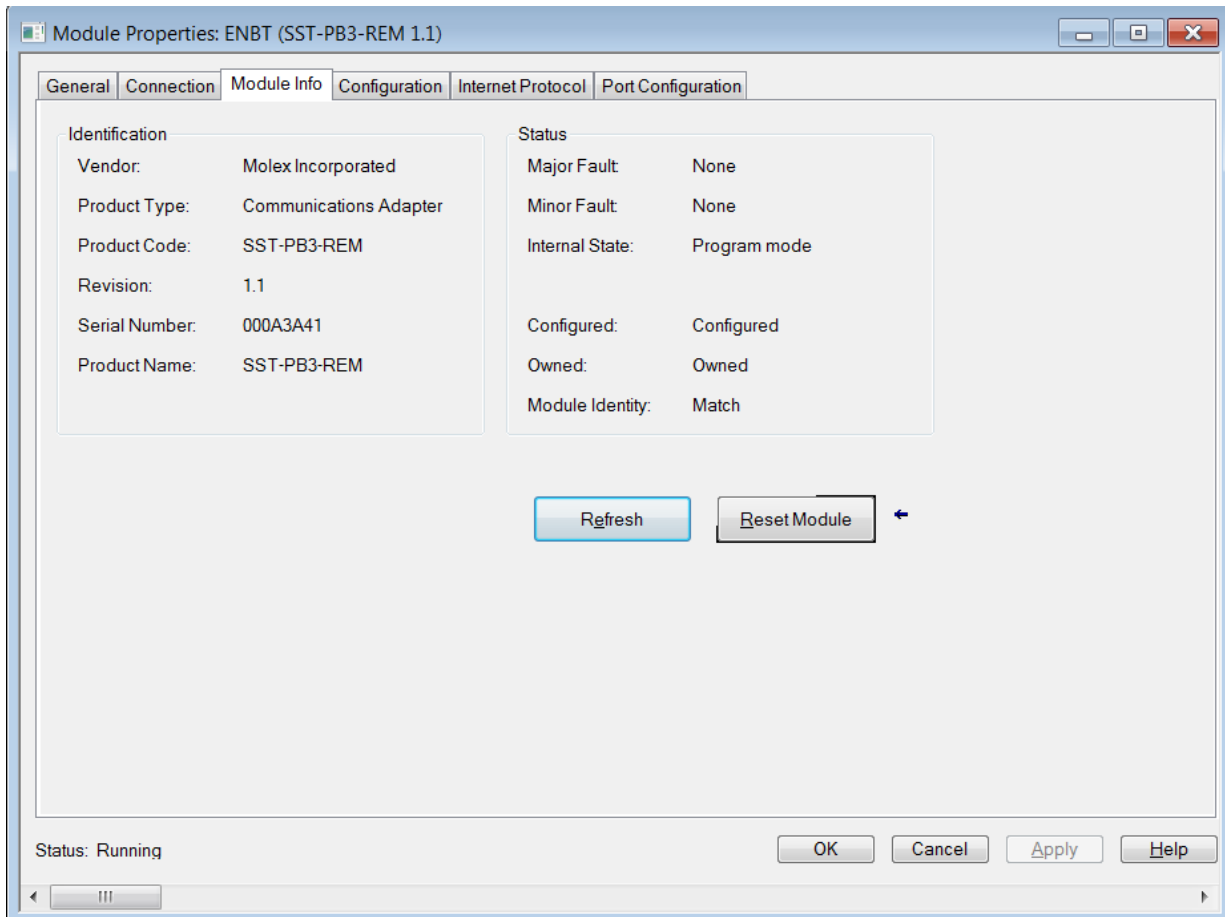

5.5.6 Configuring the IP Settings and configuration via EDS AOP

1. While online, select the Internet Protocol tab to enable configuring IP setting manually or obtain IP settings automatically using DHCP.
2. Change the IP Address of the SST-PB3-REM if required under IP Settings Configuration.



Note

The Lower rotary switch on the back of module has to be in C position in order to change the Ethernet configuration port settings and store in flash.

Module Properties: ENBT (SST-PB3-REM 1.1)

General | Connection | Module Info | Configuration | **Internet Protocol** | Port Configuration

Internet Protocol (IP) Settings
 IP settings can be manually configured or can be automatically configured if the network supports this capability.

Manually configure IP settings

Obtain IP settings automatically using DHCP

IP Settings Configuration

Physical Module IP Address: 192 . 168 . 1 . 71 Subnet Mask: 255 . 255 . 255 . 0

Gateway Address: 0 . 0 . 0 . 0

Domain Name:

Host Name:

[Refresh communication](#) ←

Status: Running

3. A soft reset of the module is required in order for the new Ethernet Port settings to take effect. Resetting the module can only be done when the PLC state is in PROG state or OFF State (Connection Inhibited) and is done by going to the Module Info tab and selecting the Reset Module button.

5.5.7 Selecting the Port Configuration Tab in EDS AOP

1. Select the Port configuration tab to view the current settings of Ethernet ports 1 or 2 need changing.
2. If port configuration needs modifying, inhibit the Remote Module first by going to the connection tab and selecting inhibit module. For changes to port configuration to take effect, the module must be reset.



Note

10 MB Half/Full is not supported for the Remote Module.
100MB Full/Half is available

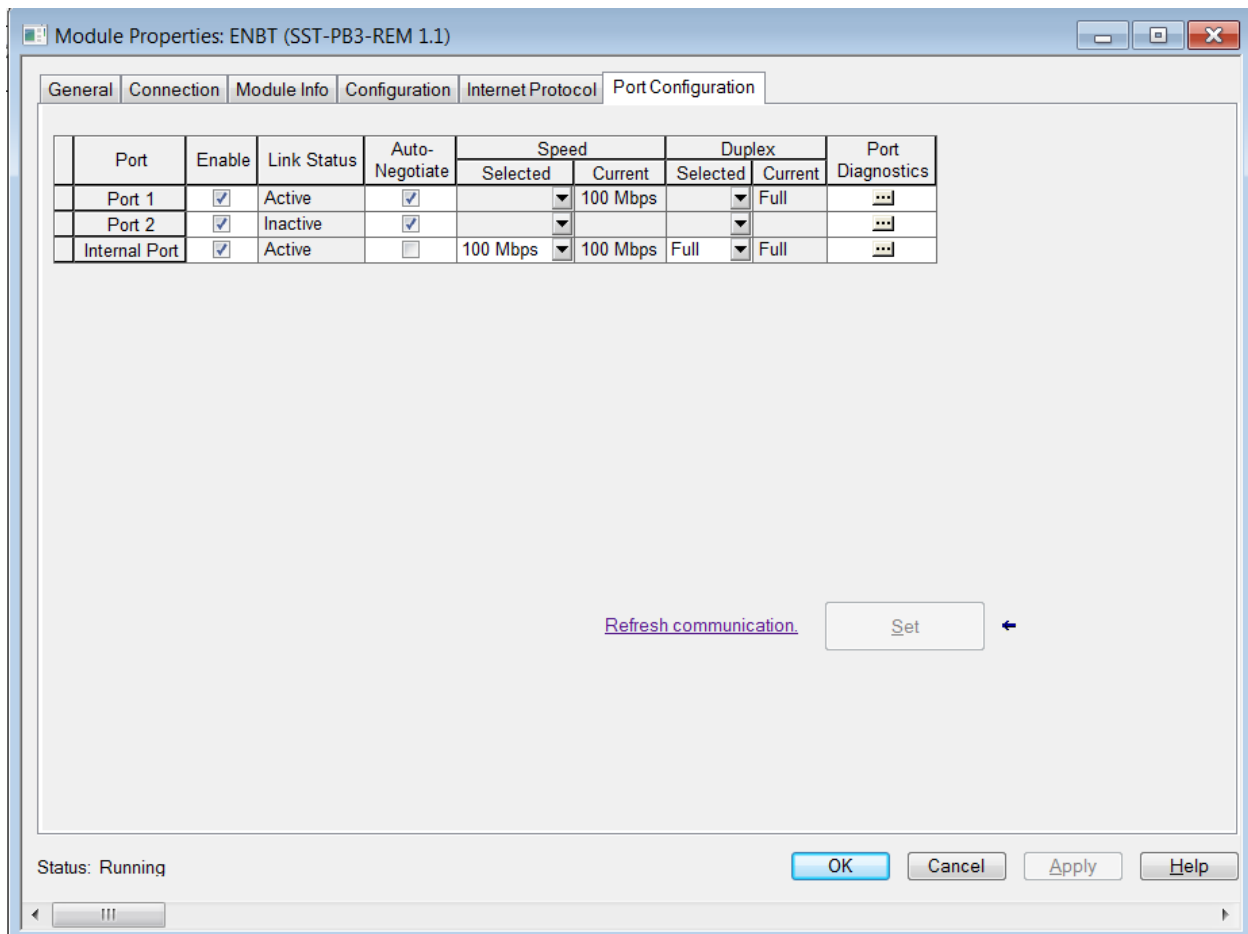

3. Select Close. SST-PB3-REM is now configured as below.

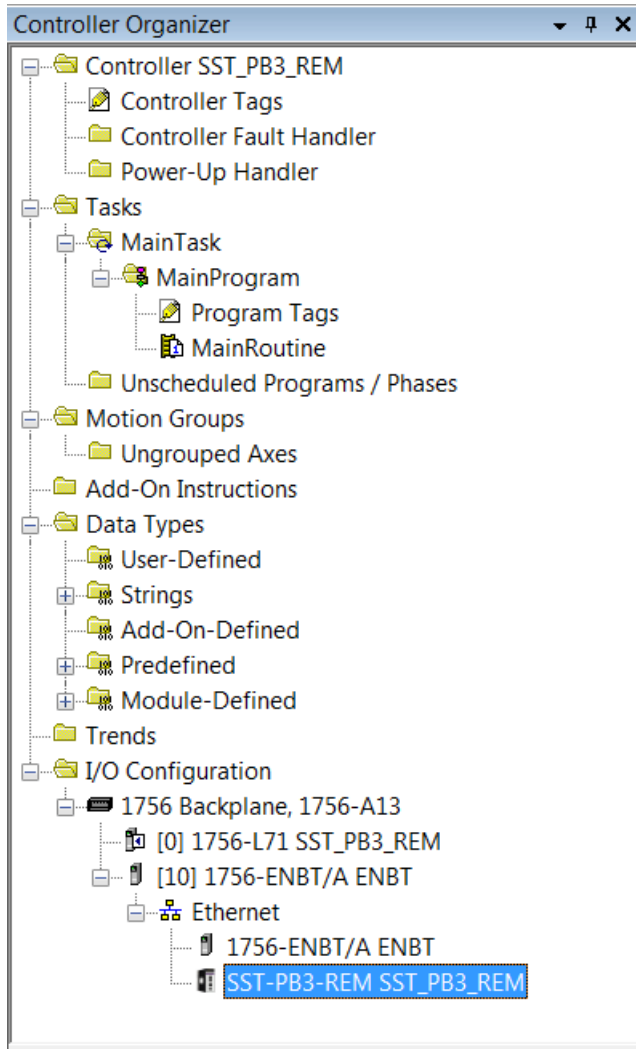

After adding SST-PB3-REM to the I/O Configuration, the following tags for the SST-PB3-REM will be created and can be found under Controller tags. These will be the tags to reference if using Raw (Manual) data mode. In the example below, the 1st Exclusive connection (Input Assembly 111 and Assembly 121) and Status Input Only connection (Status Assembly 131) were configured.

Name	Value	Force Ma	Style	Data Type	Description
SST_PB3_REM:C	{...}	{...}		_0008:SST_PB3_REM_25E29816:C:0	Configuration Assembly 131
+ SST_PB3_REM:C.Data	{...}	{...}	Decimal	SINT[8]	Configuration Assembly 131
SST_PB3_REM:I1	{...}	{...}		_0008:SST_PB3_REM_7E6CF713:I:0	Input Assembly Assembly 111
- SST_PB3_REM:I1.ConnectionFaulted	0		Decimal	BOOL	Input Assembly Assembly 111
+ SST_PB3_REM:I1.Data	{...}	{...}	Decimal	SINT[500]	Input Assembly Assembly 111
SST_PB3_REM:I2	{...}	{...}		_0008:SST_PB3_REM_7E6CF713:I:0	Status Assembly 161
- SST_PB3_REM:I2.ConnectionFaulted	0		Decimal	BOOL	Status Assembly 161
+ SST_PB3_REM:I2.Data	{...}	{...}	Decimal	SINT[500]	Status Assembly 161
SST_PB3_REM:O1	{...}	{...}		_0008:SST_PB3_REM_78F5E13D:O:0	Output Assembly 121
+ SST_PB3_REM:O1.Data	{...}	{...}	Decimal	SINT[496]	Output Assembly 121

If the Profibus configuration has been created in Tag mode then the L5X file generated for the Profibus configuration would need to be imported into Studio 5000 to reference the SST-PB3-REM that was just created using the Remote Module's EDS AOP (Add-On-Profile). Refer to the next section on importing L5X file into Rslogix5000.

5.6 Importing the L5X File into RSLogix5000

1. Right-Click on Add-On Instruction in the Controller Organizer.

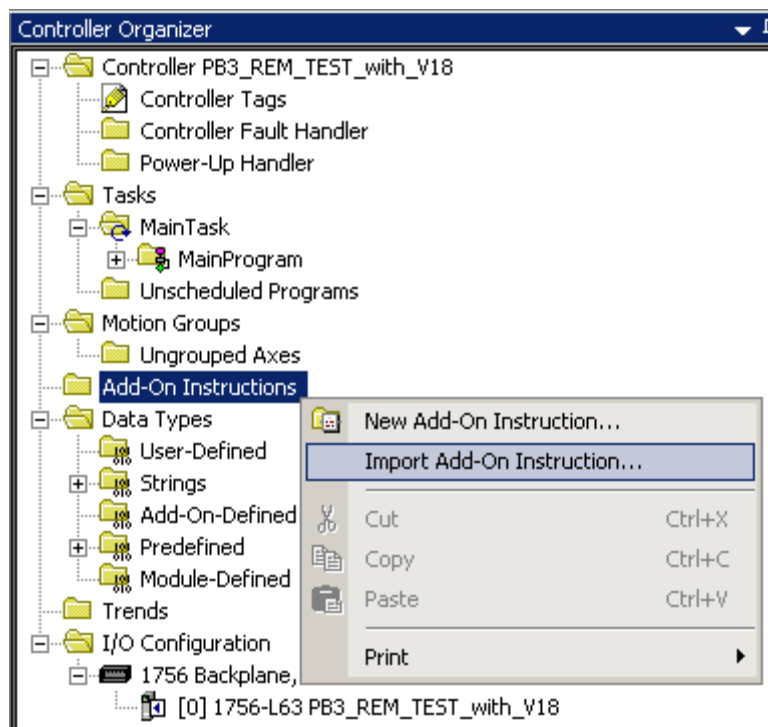

2. Browse for L5X file.

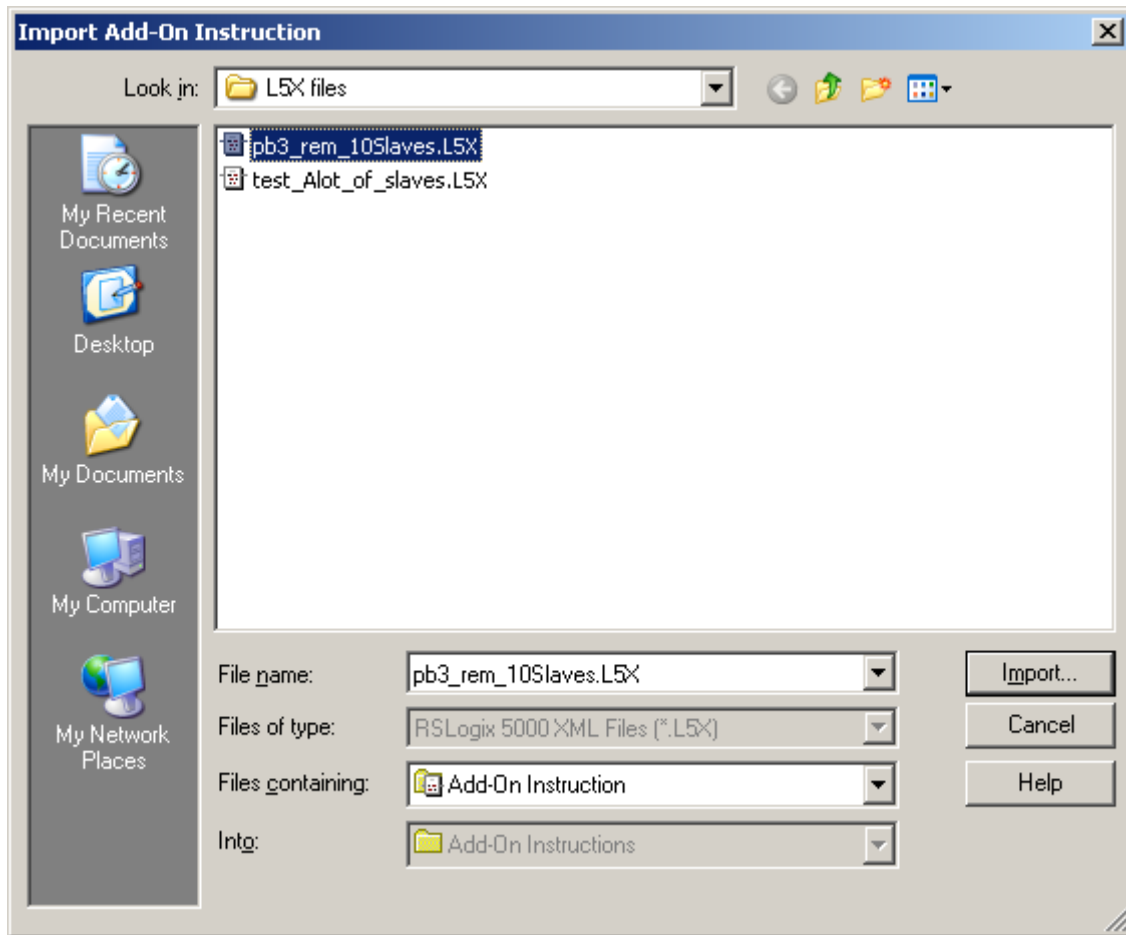

3. Select Import.
4. Import Configuration Dialog is displayed.

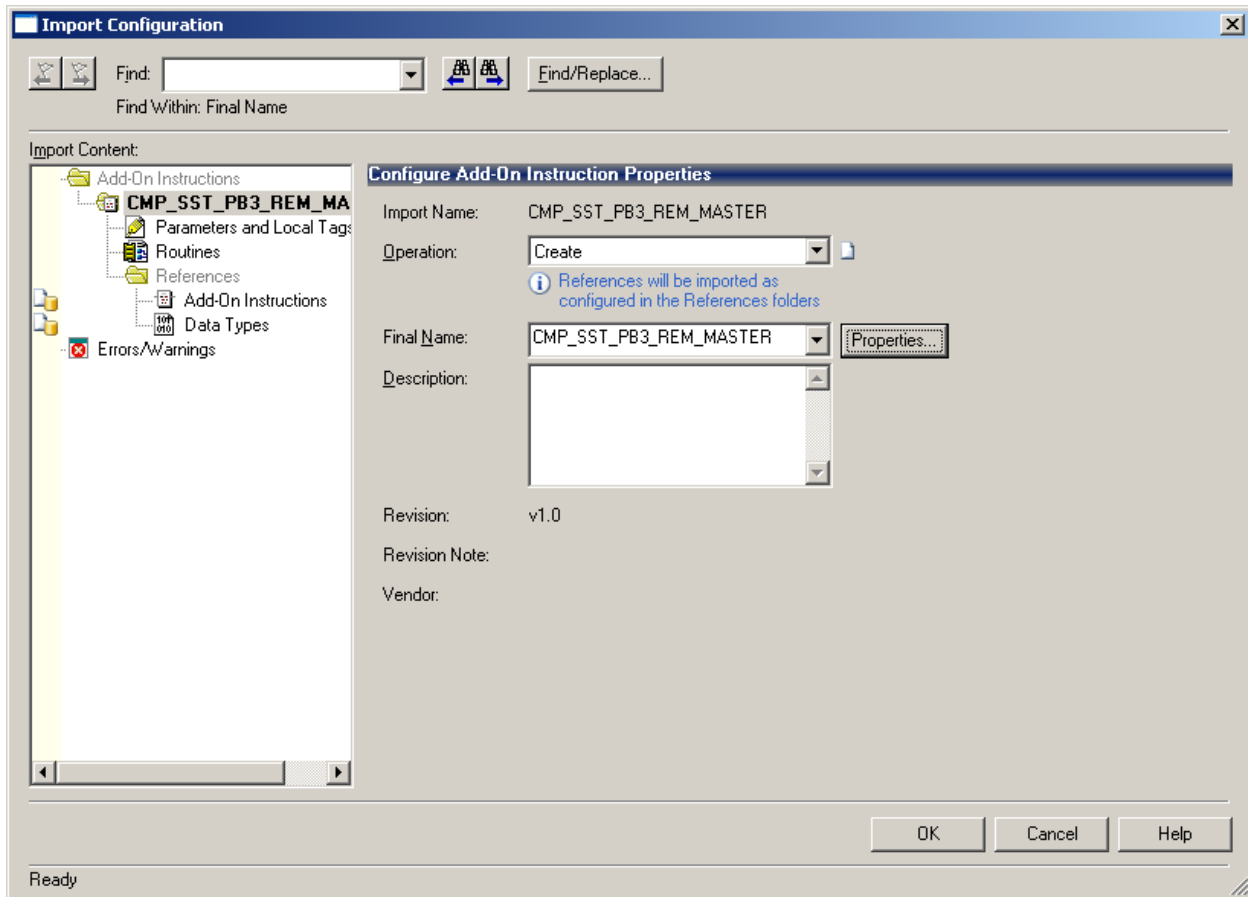

5. If this is the first time the L5X project is being imported select OK and proceed to step 13. If the L5X has previously been imported refer to the following steps before clicking on OK button in the Import Configuration Dialog box.

6. When importing a L5X file into a project that already has imported AOIs and UDTs from the configuration tool, a similar screen will appear as below.

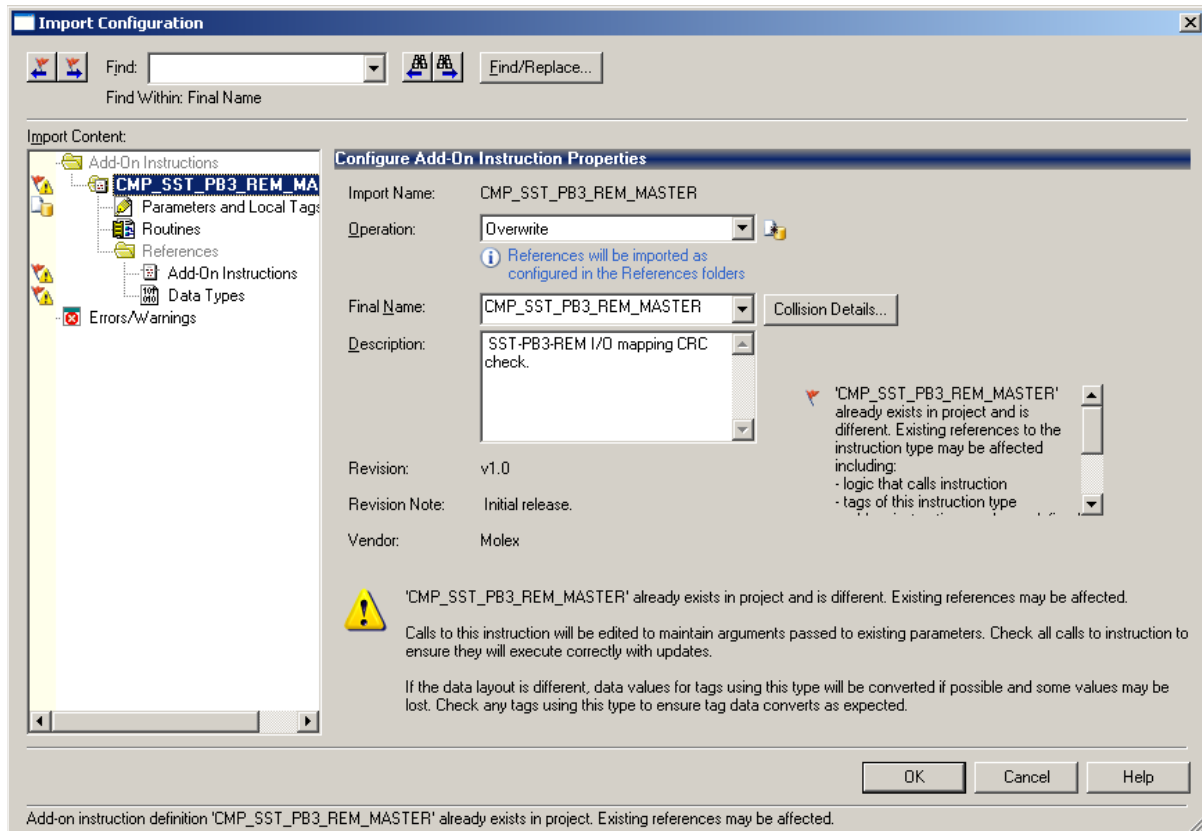

7. Accept the recommended settings to overwrite the AOI instruction “CMP_SST_PB3_REM_MASTER”. Anytime the configuration is updated the CRC value will change and this existing AOI will need to be overwritten.
8. Click on Add-On-Instructions underneath References.

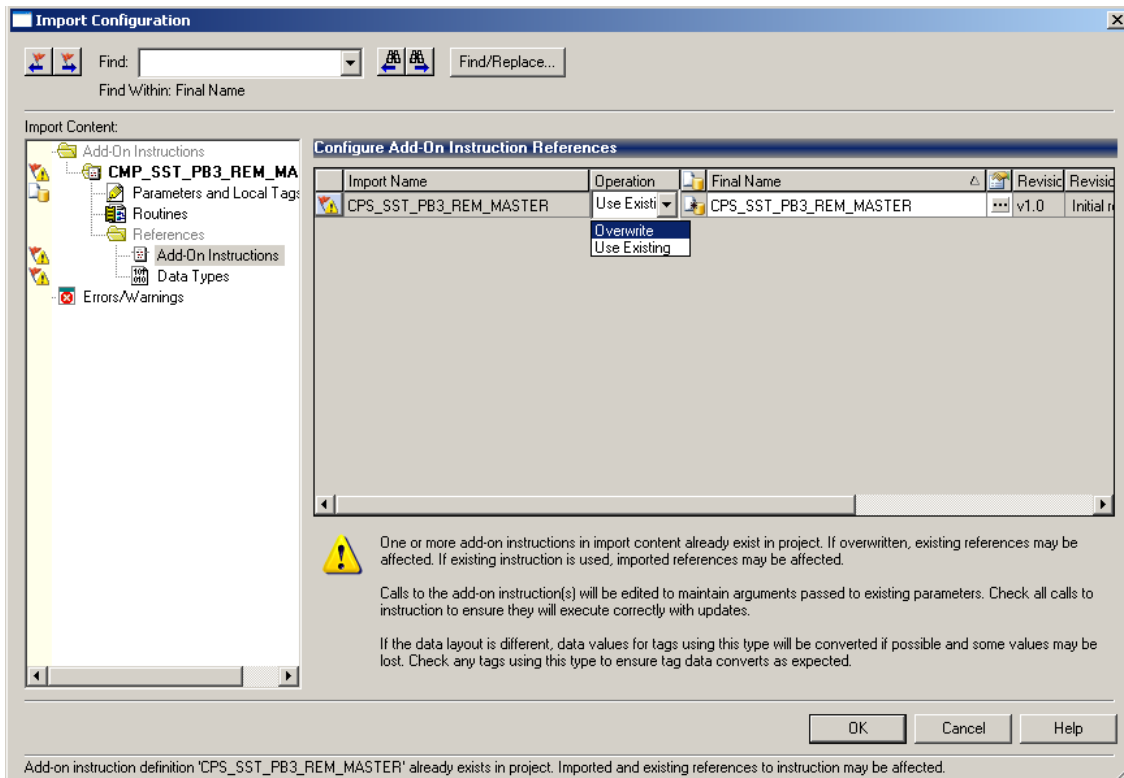

9. After selecting Add-On Instructions (Under references) on the right-hand side in the “Configure Add-On Instruction References” dialog, change the operation to Overwrite so that the CPS_SST_PB3_REM_MASTER AOI is overwritten in project.
10. Next select Data Types.

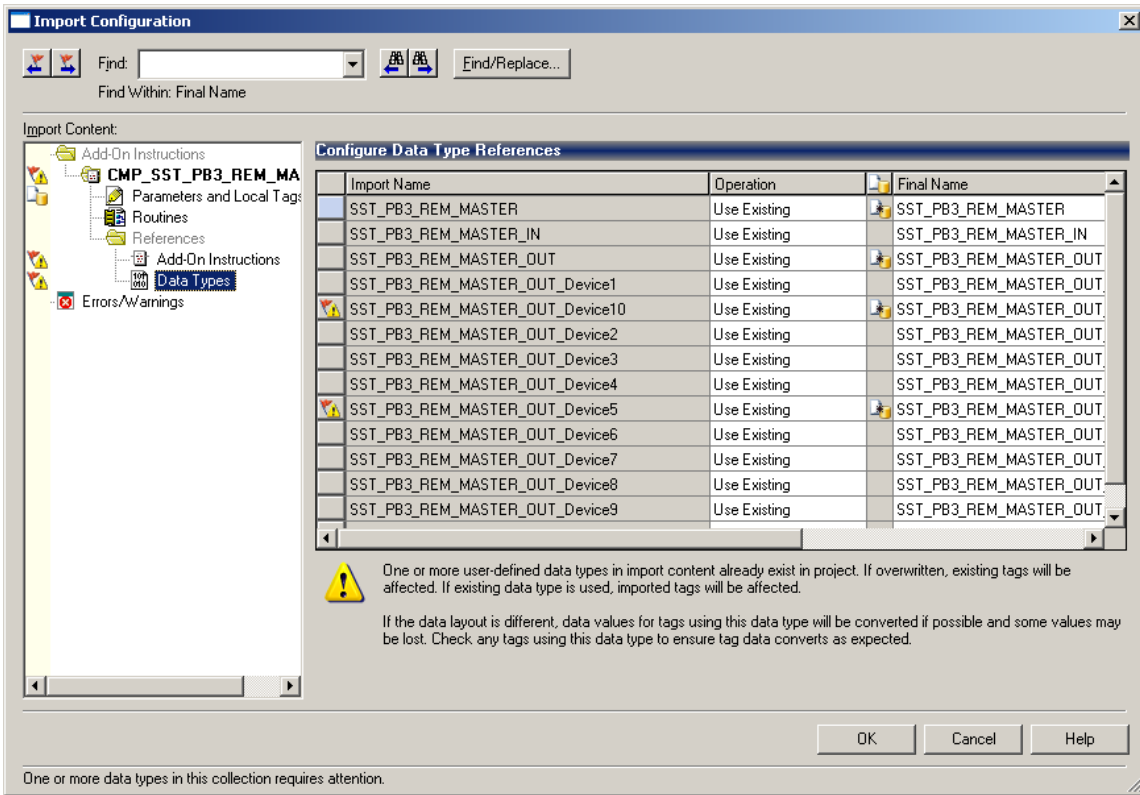

11. In the example above, two slaves UDTs (for Device10 and Device5) have changed. Change the Operation for both devices to Overwrite. The dialog be similar to below.

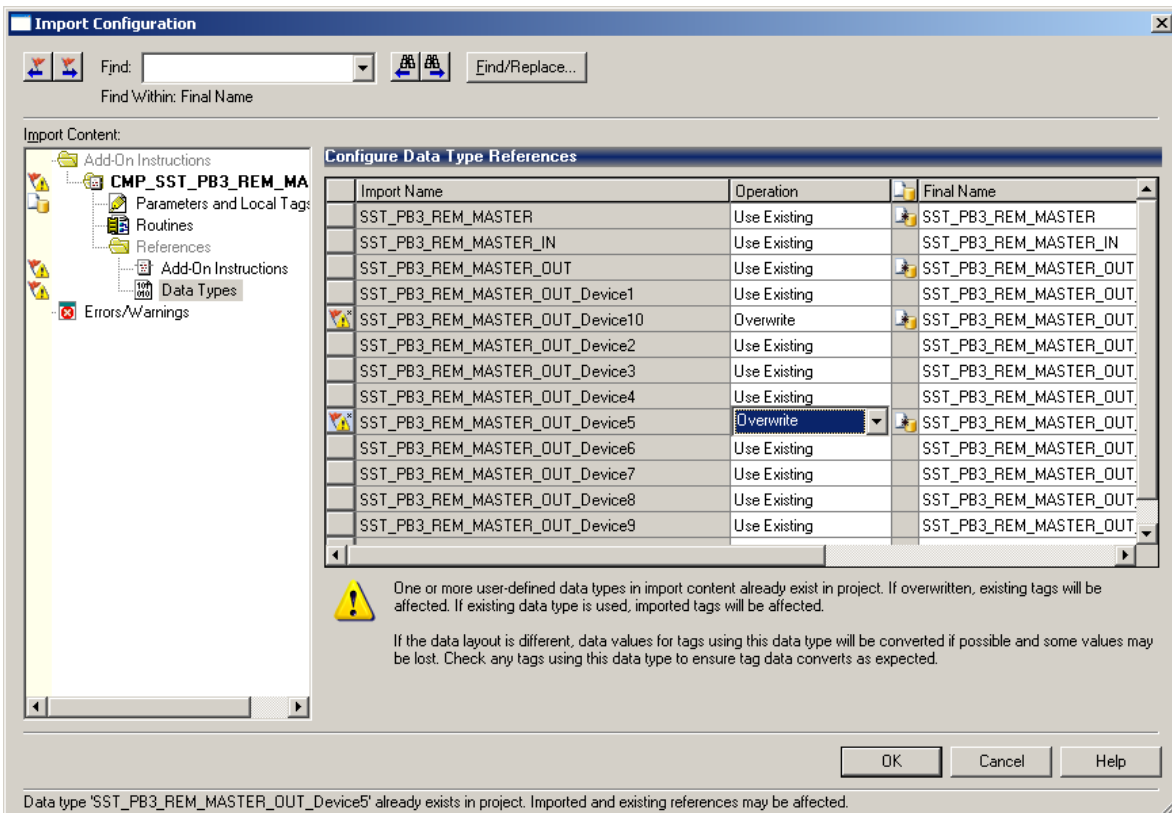

12. Click OK button to import the L5X file.

Two Add-On instructions and several UDTs will be imported and appear similarly to below. The CMP_SST_PB3_REM_MASTER AOI is used for verifying the L5X CRC to make sure it is valid.

The CPS_SST_PB3-REM_AOI is used for copying data from the input assemblies into SST_PB3_REM_MASTER UDT and output from SST_PB3_REM_MASTER UDT into the output assemblies. The instruction also copies data from the status assembly into the master UDT.

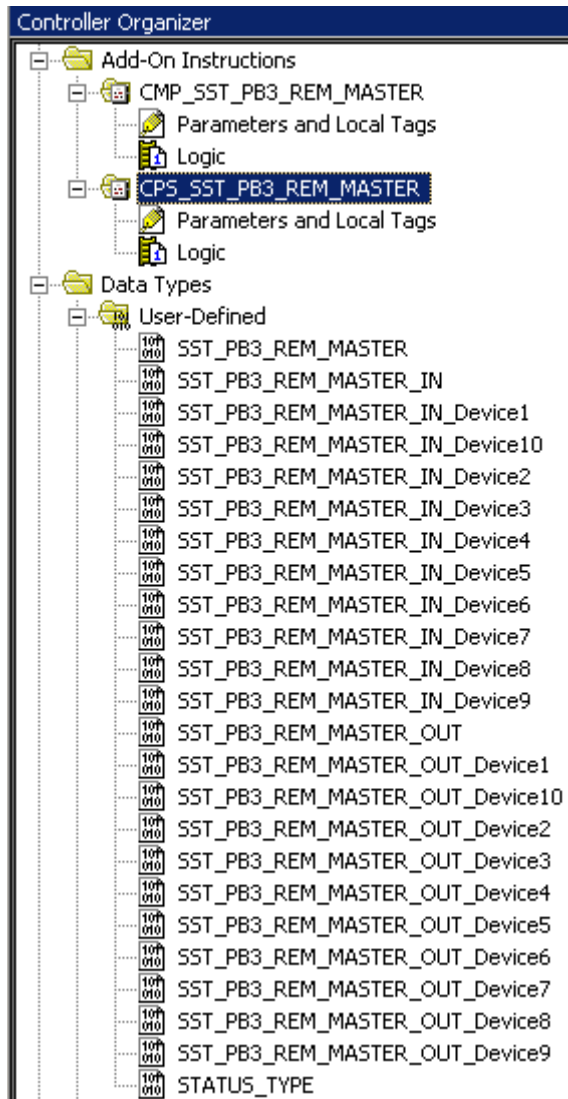

5.7 Using Provided AOIs

The L5X file provides two AOIs for ease of programming. These are *CMP_MASTER NAME* and *CPS_MASTER NAME*. In the examples below, the master name is *SST_PB3_MASTER*.

CMP_MASTER NAME compares the I/O CRC provided by the L5X file with the CRC from the configuration. This ensures synchronization between the L5X file and the configuration from flash.



Note

The I/O CRC can also be checked when the connection with the controller is established. The 4 bytes I/O CRC value from Profibus configuration can be entered into bytes offsets 4 to 7 of configuration assembly 131. If the values are not 0, the CRC is compared with the CRC from the Profibus configuration in module's flash. If they are not matching, the connection is refused.

CPS_MASTER NAME copies data between the I/O assemblies and the master UDT.

1. Select the program and the rung to use for the Add-On instruction.
2. Go to the instruction toolbar and select Add-On.



3. Select CMP SST from the instruction toolbar.



4. Create a new tag for *CMP_SSTPB3_REM_MASTER* Parameter by right-clicking on right side of *CMP_SSTPB3_REM_MASTER* Parameter and selecting New Tag...

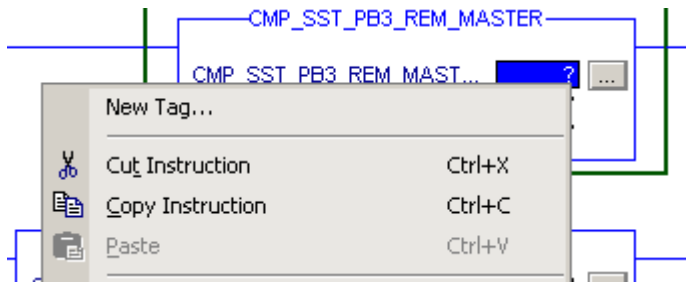

5. Enter Name for tag and click OK.

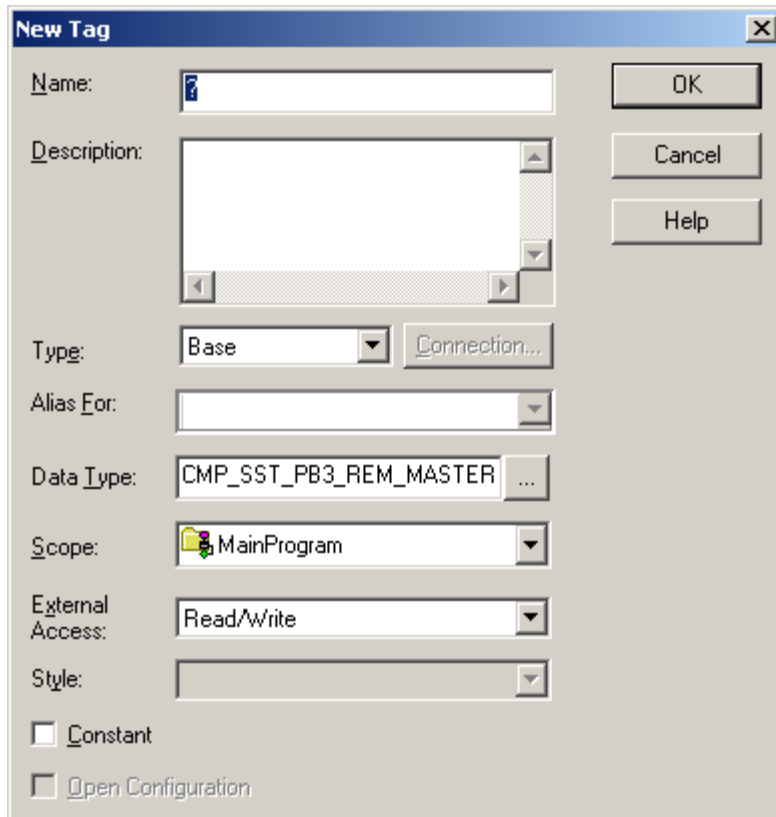

6. Create a new tag for the IO_MAPPING_CRC by right-clicking on right side of IO_MAPPING_CRC and selecting New Tag...

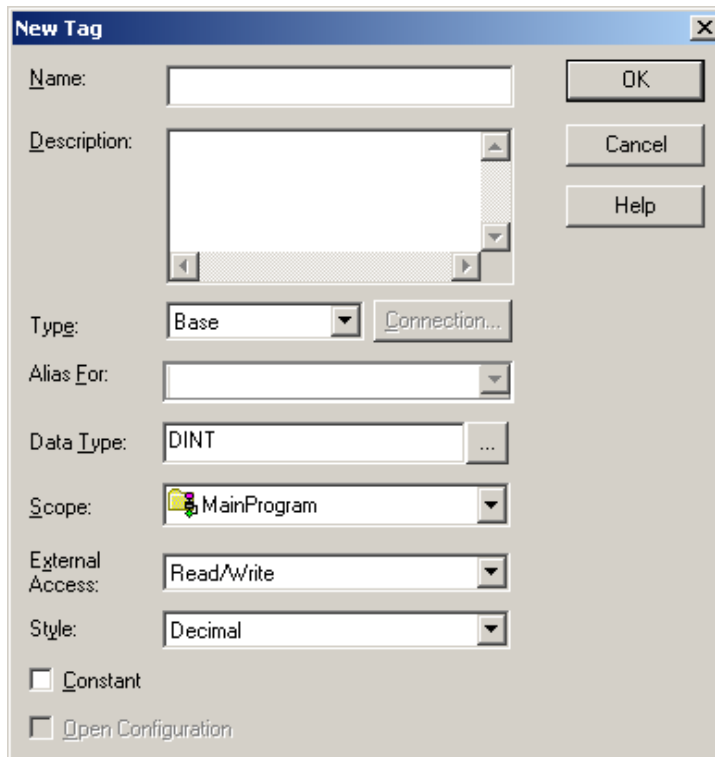

- Enter Name for tag and hit OK. The value of this tag must be updated with the I/O CRC value this is created for the Profibus configuration in the SST™ Profibus Configuration Tool. Double-click on SST-PB3-REM Master in your configuration and go to Parameters tab and the I/O CRC value will be in right bottom corner as in screenshot below.

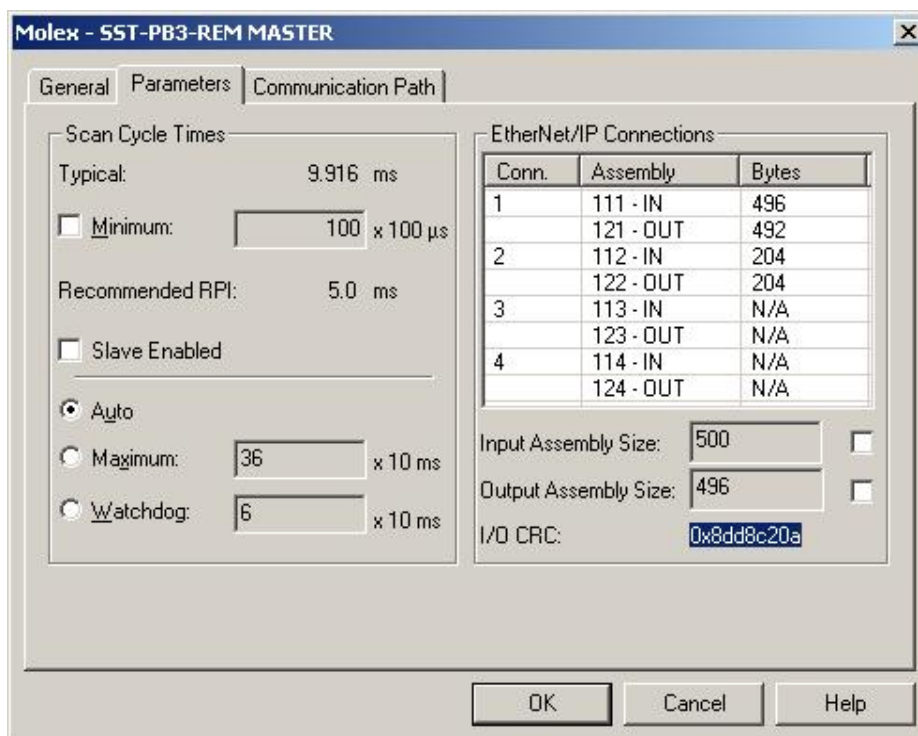

- Create a new tag for the Is_CRC_Ok parameter by right-clicking on right side of the

Is_CRC_Ok parameter and selecting New Tag...

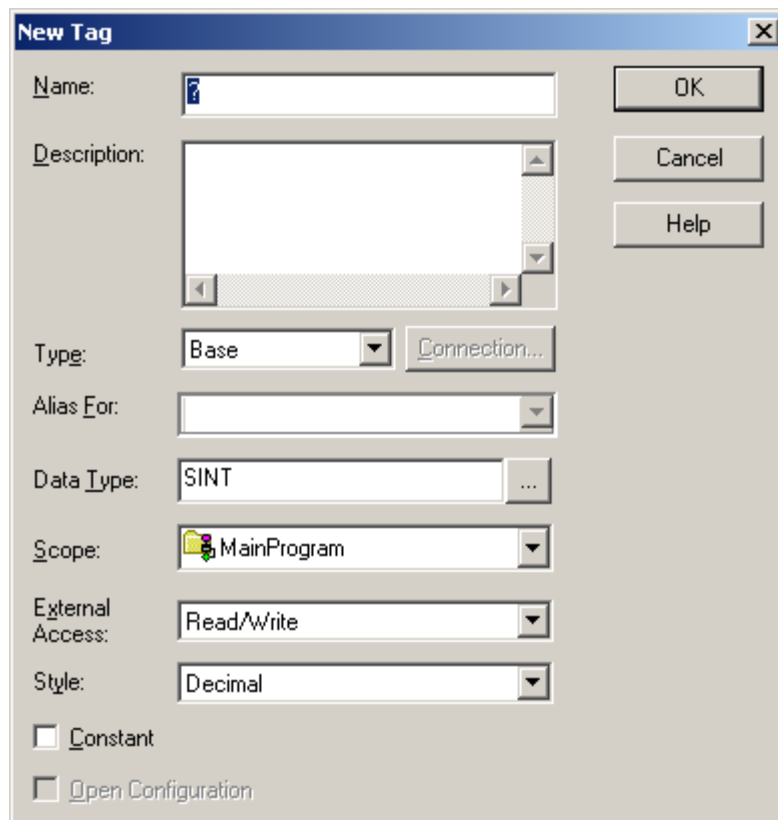

9. Enter a name for tag and hit OK.

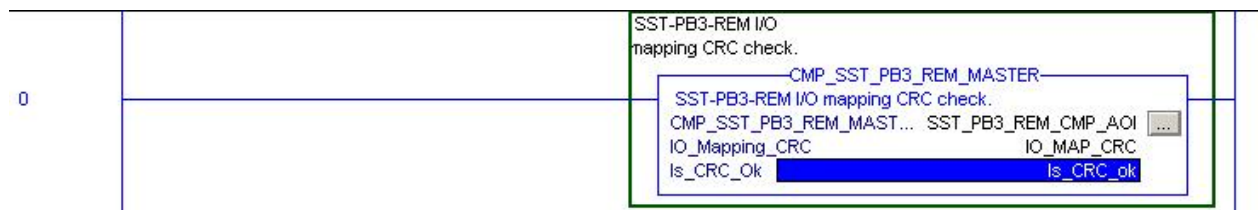

10. The CMP_SST_PB3_REM_MASTER AOI is configured. This AOI only needs to be executed once and must be called prior to calling CPS_SST_PB3_REM_MASTER AOI.
11. Go to the instruction toolbar and select Add-On.

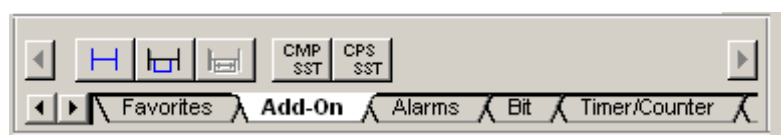

12. Select CPS_SST_PB3_REM_MASTER from the instruction toolbar. In this example, only 1 Exclusive Owner connection has been defined for the SST-PB3-REM which is why only 2 I/O assembly parameters are displayed for this AOI. The number of I/O assembly parameters will equal the number of Exclusive Owner connections multiplied by two.

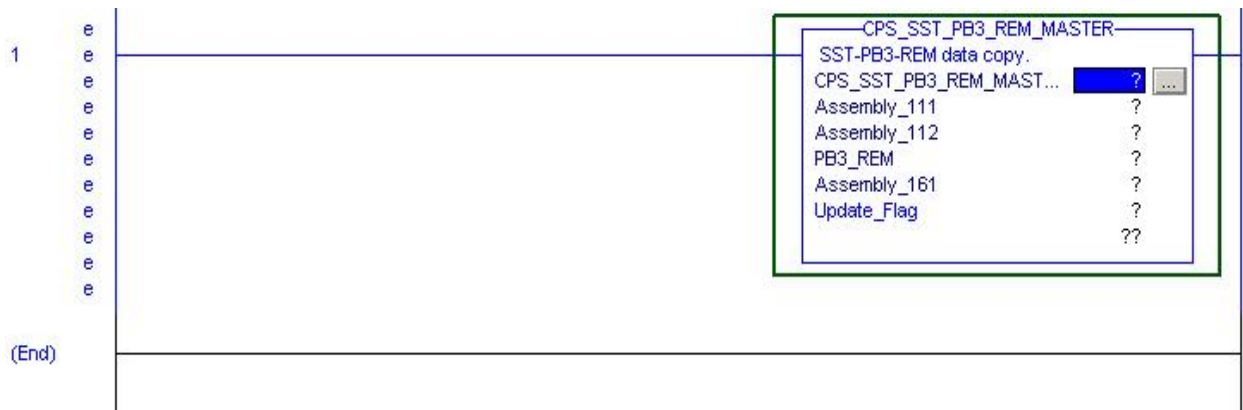

13. Create a new tag for CPS_SST_PB3_REM_MASTER by right-clicking on highlighted area.

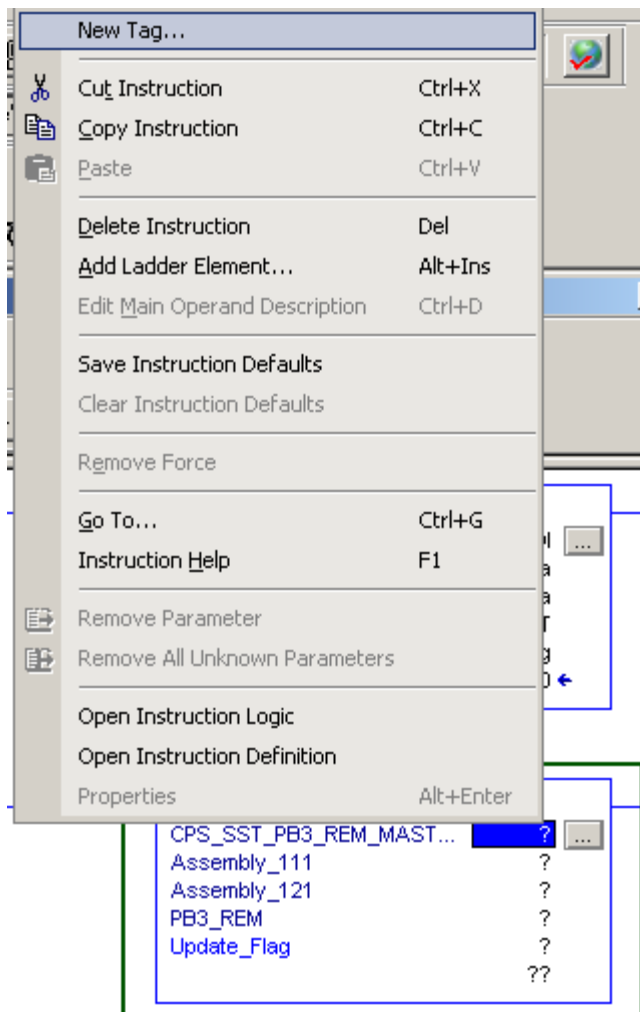

14. New Tag Dialog box will appear. Enter Name for tag and select OK.

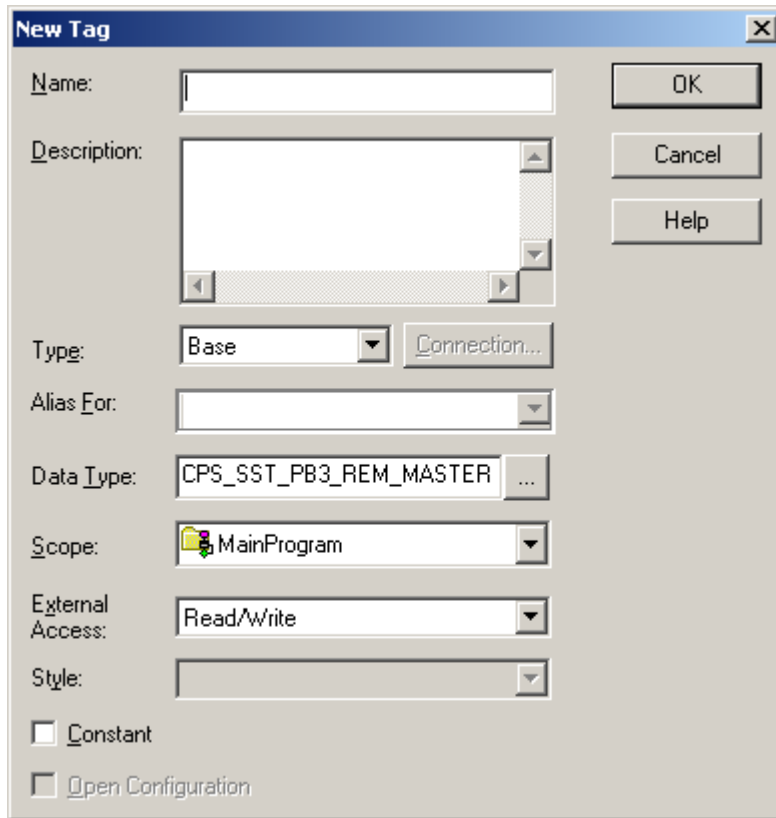

15. Specify the input assembly for Assembly_111 parameter and hit Enter key.

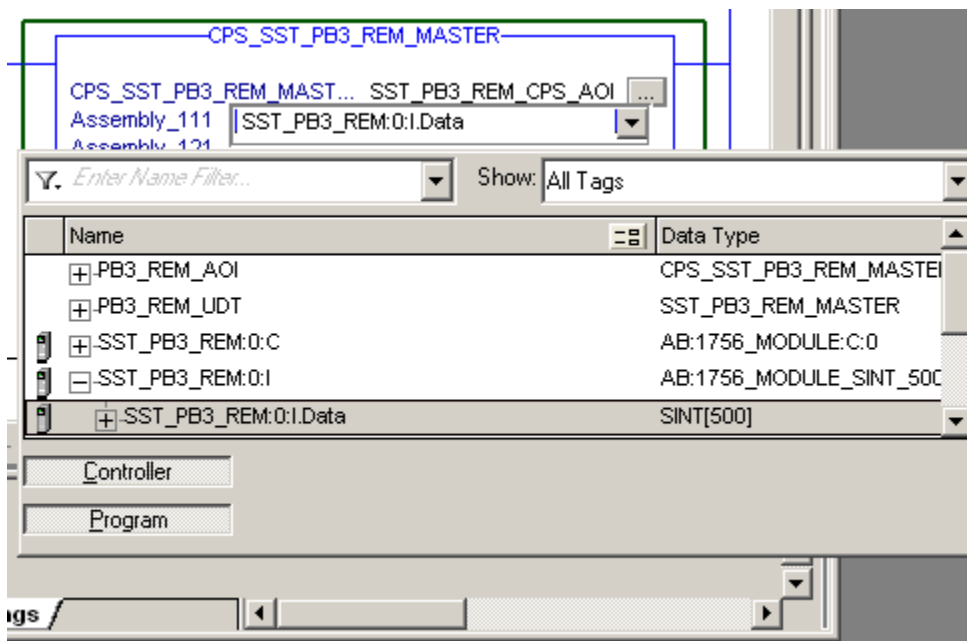

16. Specify the output assembly for Assembly_121 parameter and hit Enter Key.

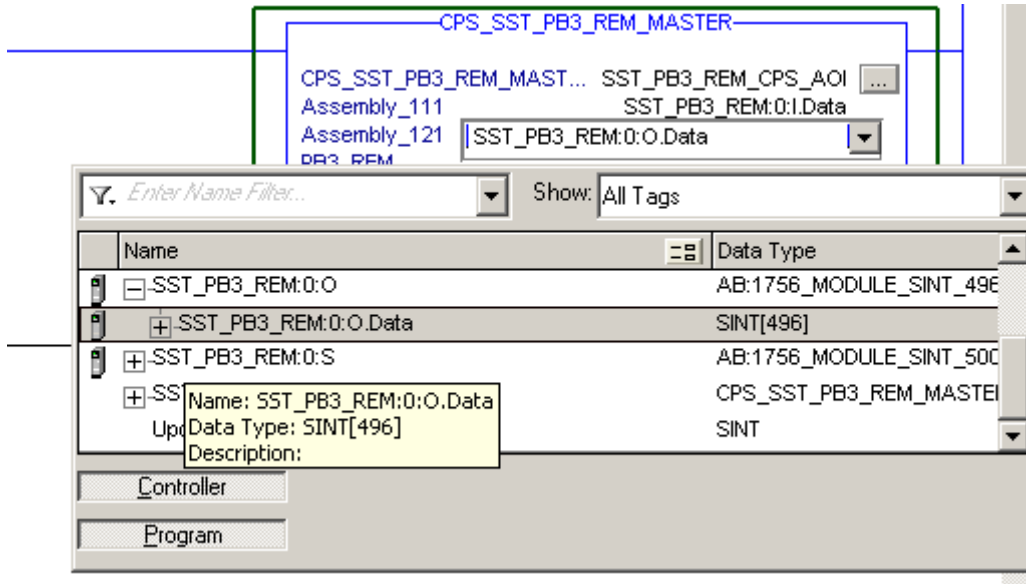

17. Create a UDT tag for SST-PB3-REM by right-clicking on right side of PB3_REM parameter and selecting New Tag...

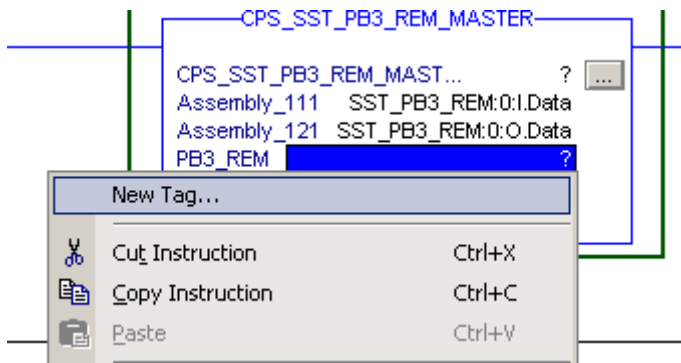

18. Enter Name for tag and hit OK.

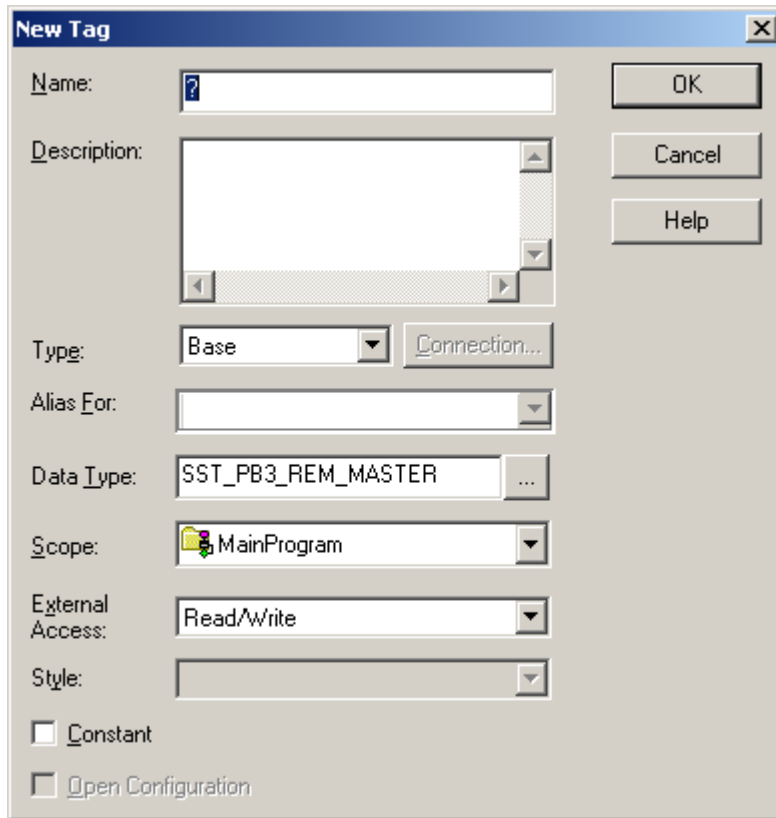

19. Create a new tag for Update_Flag parameter by right-clicking on right side of Update Flag parameter and selecting New Tag...

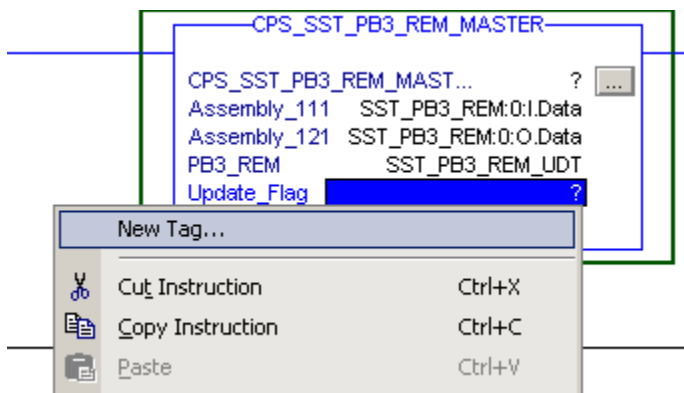

20. Enter name for tag and hit OK.

New Tag [X]

Name: [?]

Description: []

Type: Base [v] Connection...

Alias For: []

Data Type: INT [...]

Scope: [MainProgram]

External Access: Read/Write [v]

Syle: Decimal [v]

Constant

Open Configuration

OK

Cancel

Help

21. Your Add-On instruction is complete.

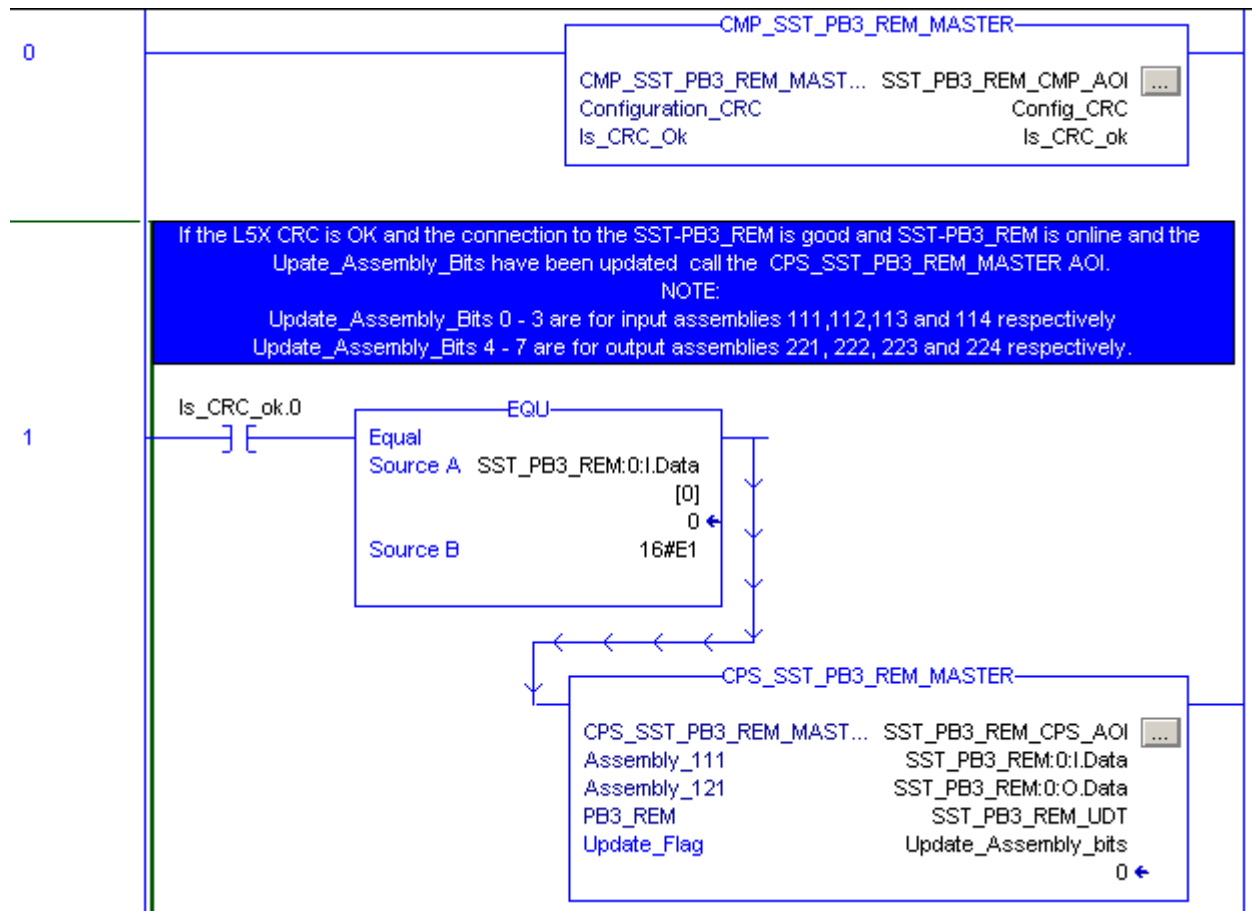

22. The following must be done prior to calling the CPS_SST_PB3_REM_MASTER AOI (see above):

- The CMP_SST_PB3_REM_MASTER AOI has executed and returned TRUE for bit 0 of tag for Is_CRC_Ok parameter.
- Update_Flag must be updated. This is used to specify which input and output assemblies to update.
 - Bits 0 -3 represent input assemblies 111,112,113, and 114 respectively.
 - Bits 4 – 7 represent output assemblies 121, 1212, 123 and 124 respectively.
 - Bit 8 represents status assembly 161.
- All configured CIP connections must be opened to the module and SST_PB3_REM Master must be online.

5.8 PLC Connection Error Codes

Name	CIP Error	Description
CRC_PERMISSION_DENIED	0x0F	IO CRC does not match
NOT_IN_MASTER_STATE	0x10	Not in master state (no configuration file in flash)
NOT_IN_SLAVE_STATE	0x10	Not in slave state (configuration file present in flash)
CNX_OUT_OF_SEQ	0x0C	The module received a connection request without before opening the first connection (111/121/131)
BAD_PARAM_AUTORUN	0x09	Invalid parameter for Autorun flag (0 or 1 are valid)
BAD_PARAM_SLV_INPUT	0x09	Slave input length to long (over 244)
BAD_PARAM_SLV_OUTPUT	0x09	Slave output length to long (over 244)
BAD_PARAM_SLV_STN_NUM	0x09	Slave station number to high (over 125)
BAD_PARAM_SLV_BAUD	0x09	Baud rate invalid (0 – 11 are valid)
BAD_PARAM_SWAP_WORD	0x09	Invalid parameter for swap word flag (0 or 1 are valid)

6

EtherNet/IP Assemblies

Chapter Sections:

- Exclusive Owner
- Input Only
- Making Changes to the Configuration Assembly

6.1 Exclusive Owner

6.1.1 I/O Assemblies

As previously mentioned in section 2.3, EtherNet/IP Assemblies Overview, internal to the SST-PB3-REM module, Profibus data is mapped to EtherNet/IP assemblies. In addition to I/O data, the first 4 bytes of the I/O assemblies (not configuration) corresponding to the first Exclusive Owner connection have a special meaning. When the module is configured as Master only or Master/Slave the I/O assemblies corresponding to the first Exclusive Owner connection are 111 (input) and 121 (output). When the module operates in Slave only mode the I/O assemblies corresponding to the first (and only) Exclusive Owner connection are 142 (input) and 152 (output). Note that when the module operates in Master or Master/Slave mode these 4 bytes are also mapped in the master UDT provided by the SST™ Profibus Configuration Tool.

Primarily, the purpose of these bytes is to provide a command interface between the module and the controller program. Some status information may also be retrieved via this interface.

The rest of the input (112, 113, 114, 141) and output (122, 123, 124, 151) assemblies contain Profibus I/O data only.

Table 6.1-1: Assembly 111 or 142 – Input Process Data

Area Description	Area Layout	Meaning/Description	Data type	Byte offset
Input Data Area	Module Status(bits 0 -7)	Indicates whether the module is active or inactive on the Profibus network.	WORD	0
	Module Command Reply	Echo of CMD Control in the Output Data Area.	WORD	2
	Input Data	Profibus input data, user defined.	BYTE[496]	4

Table 6.1-2: Module Status Values

Value	Meaning/Description
E0h	Scanner is not online on Profibus. Issue the PFB_START_BUS command to put it online.
E1h	Scanner is online on Profibus.

Table 6.1-3: Module Command Reply Values

Value	Meaning/Description
00h	No Command
01h	PFB_BUS_RUN_MODE has been processed
02h	PFB_BUS_CLR_MODE has been processed
03h	PFB_CLR_ERR_CNT has been processed
04h	PFB_START_BUS- has been processed
07h	PFB_STOP_BUS has been processed

0Ch	SEND_SYNC_COMMAND has been processed
0Dh	SEND_UNSYNC_COMMAND has been processed
0Eh	SEND_FREEZE_COMMAND has been processed
0Fh	SEND_UNFREEZE_COMMAND has been processed

Table 6.1-4: Assembly 121 or 152 – Output Process Data

Area Description	Area Layout	Meaning/Description	Data type	Byte offset
Output Area	CMD Control	Issue a command to scanner See CMD Control Register values below	WORD	0
	CMD Argument (low byte, bits 0-7)	Command argument – only required for commands that require an additional parameter, "Group ID". These commands are: SEND_SYNC_COMMAND SEND_UNSYNC_COMMAND SEND_FREEZE_COMMAND SEND_UNFREEZE_COMMAND	WORD	2
	Output Data	Profibus output data, user defined.	BYTE[492]	4

**Note**

After writing a command, clear the command by first waiting for the Command Reply Register to echo the command and then write 0 to it. Clearing it to zero after will stop the console from executing the command when a command is executed in console.

Table 6.1-5: CMD Control Values

Value	Meaning/Description
00h	No Command.
01h	PFB_BUS_RUN_MODE – Put Profibus into run mode.
02h	PFB_BUS_CLR_MODE – Put Profibus into clear mode.
03h	PFB_CLR_ERR_CNT – Clear counters in the Status area.
04h	PFB_START_BUS – Put scanner online on Profibus.
07h	PFB_STOP_BUS – Put scanner offline on Profibus.
0Ch	SEND_SYNC_COMMAND – This command sends the SYNC command along with the Group ID, on the Profibus network. The Group ID is set in the CMD Argument register. This command is for updating output data on slaves. Slaves will not accept output data until the next SYNC command is sent again or the UNSYNC command is sent.

	Group ID is an 8 bit field (0 – 7 and each of the bits represent a Group: group 0 (bit 0) is for sending to all slaves in the Master scan list).
0Dh	SEND_UNSYNC_COMMAND – This command sends the UNSYNC command along with the Group ID, on the Profibus network. The Group ID is set in the CMD Argument register. This command causes outputs on the slave(s) to continue to be updated cyclically again.
0Eh	SEND_FREEZE_COMMAND – This command sends the FREEZE command along with the Group ID, on the Profibus network. The Group ID is set in the CMD Argument register. This command causes the slave inputs to “freeze” until the next FREEZE command is received.
0Fh	SEND_UNFREEZE_COMMAND – This command sends the UNFREEZE command along with the Group ID, on the Profibus network. The Group ID is set in the CMD Argument register. This command removes the FREEZE on slave inputs and allows them to be updated cyclically again.

6.1.2 Configuration Assemblies

Before establishing an EtherNet/IP connection with SST-PB3-REM, certain module configuration parameters may be set in the configuration assembly. There are two configuration assembly instances supported by SST-PB3-REM: 131 (size 0 or 8 bytes) when the module operates in Master or Master/Slave mode and 132 (size 6 bytes) when the module operates in Slave only mode.

Table 6.1-6: Assembly 131 – Master or Master/Slave mode

Area Description	Area Layout	Values	Meaning/Description	Data type	Byte offset
Configuration	Auto Run	0 or 1	If set to 1, as soon as the connection is established, the module will be automatically put online on the Profibus network and enter the mode that the controller is in (RUN or PROG). Default value is 0.	BYTE	0
	Slave Input Length	0-244	The length of the Slave Inputs in bytes, it must be an even number. Default value is 0.	BYTE	1
	Slave Output Length	0-244	The length of the Slave Outputs in bytes, it must be an even number. Default value is 0.	BYTE	2
	Swap Words	0 or 1	If set to 1, the slave input and output words will be swapped when copying data between the Profibus process and EtherNet/IP I/O assemblies. Default value is 0.	BYTE	3
	Expected CRC	0 or non 0	If non 0, at connection establishment time the module verifies this value matches the I/O CRC of the configuration stored in flash and rejects the connection on mismatch. Default value is 0.	BYTE	4 - 7



Note

If both slave input and output length are left at 0, the DP slave functionality is not activated on the module.

Table 6.1-7: Assembly 132 – Slave only mode

Area Description	Area Layout	Values	Meaning/Description	Data type	Byte offset
Configuration	Auto Run	0 or 1	If set to 1, as soon as the connection is established, the module will be automatically put online on the Profibus network and enter the mode that the controller is in (RUN or PROG).	BYTE	0
	Slave Input Length	0-244	The length of the Slave Inputs in bytes, it must be an even number. Default value is 0.	BYTE	1

Area Description	Area Layout	Values	Meaning/Description	Data type	Byte offset
	Slave Output Length	0-244	The length of the Slave Outputs in bytes, it must be an even number. Default value is 0.	BYTE	2
	Slave Station Number	0-125	The local Profibus station address.	BYTE	3
	Baud Rate	0-11	See Baud Rates Values table for additional information.	BYTE	4
	Swap Words	0 or 1	If set to 1, the slave input and output words will be swapped when copying data between the Profibus process and EtherNet/IP I/O assemblies. Default value is 0.	BYTE	5

Table 6.1-8: Baud Rates Values

Value	Meaning/Description
00	9.6 KBaud
01	19.2 KBaud
02	93.75 KBaud
03	187.5 KBaud
04	500 KBaud
05	750 KBaud
06	1.5MBaud
07	3 MBaud
08	6 MBaud
09	12 MBaud
10	31.25 KBaud
11	45.45 KBaud

**Note**

If any of the parameters in the Configuration assembly are set to a value outside of the allowed range, the SST-PB3-REM module rejects the connection request.

6.2 Input Only

In addition to Exclusive Owner connections, the SST-PB3-REM also supports an Input-only connection for retrieving status information (assembly instance 161). In RSLogix5000 this connection is automatically opened, along with the Exclusive Owner connection, when the user selects Data... With Status for the “Comm Format” parameter.

Table 6.2-1: Status Assembly Structure

Status Name	Meaning/Description	Data Type	Byte Offset
PfbStatus	Module Status Register	WORD	0
PfbModVer	Module Firmware Version (ex. 0x0102 = 1.02)	WORD	2
PfbMasSts	Global status for all Master blocks	BYTE	4
PfbStnAddr	PFB Local station address	BYTE	5
PfbFmsSts	Global status for all FMS blocks	BYTE	6
PfbMasCntrlCfg	DP Master options and configuration	BYTE	7
ErrLanOffline	LAN encountered errors and went into offline state	BYTE	8
Reserved_1	Reserved	BYTE	9
DiagConf	Total confirmations (to requests from us) (MAS,LAY2,FMS)	WORD	10
DiagInd	Total indications (requests to us) (MAS,LAY2,FMS)	WORD	12
ErrNotOk	Total Not OK confirmations and/or indications (MAS,LAY2,FMS)	WORD	14
DiagTokHldTime	Instantaneous token hold time in Tbits	DWORD	16
DiagMinTokHldTime	Minimum Actual token hold time in Tbits	DWORD	20
DiagMasterUpdate	Master I/O update cycles completed	WORD	24
ErrMasErr	Master->DP slave communication errors	BYTE	26
ErrReConfig	Master->DP went offline and had to be reconfigured	BYTE	27
DiagMasScanTime	Instantaneous master scan time in microseconds	DWORD	28
DiagMasMaxScanTime	Maximum master scan time in microseconds	DWORD	32
ErrInvReqLen	Invalid request length errors	BYTE	36
ErrFifo	FIFO overflow errors	BYTE	37
ErrRxOverun	Receive overrun errors	BYTE	38
ErrDbITok	Double token errors (bad wiring or hardware)	BYTE	39
ErrRespErr	Response errors (bad wiring or hardware)	BYTE	40
ErrSyniErr	Syni errors (bad wiring or hardware)	BYTE	41
ErrNetTout	Network timeout errors	BYTE	42
ErrHsa	Station higher than HSA was heard	BYTE	43
ErrStn	Duplicate Station Detected	BYTE	44
ErrPasTok	Unable to Pass Token (bad wiring or hardware)	BYTE	45
ErrLasBad	Active station list invalid (bad wiring or hardware)	BYTE	46
ErrInternal	Internal Error Code (configuration error or runtime fault).	BYTE	47
ErrArg	Additional information about the internal error code	BYTE	48
ErrEventOverun	Event queue has overflowed	BYTE	49
Reserved_2	Reserved	WORD	50
pfbliveList	Live List station	BYTE [16]	52
pfbdiaList	Diagnostic List station	BYTE [16]	68

Status Name	Meaning/Description	Data Type	Byte Offset
clvCntCfg	Control config for dp slave	WORD	84
SlvStatus	Local slave status register *see below for details	BYTE	86
SlvError	Local slave error register contains error code * see below for details	BYTE	87
IP_1	IP ADDRESS byte 1	BYTE	88
IP_2	IP ADDRESS byte 2	BYTE	89
IP_3	IP ADDRESS byte 3	BYTE	90
IP_4	IP ADDRESS byte 4	BYTE	91
MASK_1	SUB NET MASK byte1	BYTE	92
MASK_2	SUB NET MASK byte2	BYTE	93
MASK_3	SUB NET MASK byte 3	BYTE	94
MASK_4	SUB NET MASK byte4	BYTE	95
GATEWAY_1	GATEWAY byte 1	BYTE	96
GATEWAY_2	GATEWAY byte 2	BYTE	97
GATEWAY_3	GATEWAY byte 3	BYTE	98
GATEWAY_4	GATEWAY byte 4	BYTE	99
FIRM_VERSION_1	Firmware version byte 1	BYTE	100
FIRM_VERSION_2	Firmware version byte 2	BYTE	101
FIRM_VERSION_3	Firmware version byte 3	BYTE	102
FIRM_VERSION_4	Firmware version byte 4	BYTE	103
CIP_SERIAL_1	CIP serial number byte 1	BYTE	104
CIP_SERIAL_2	CIP serial number byte 2	BYTE	105
CIP_SERIAL_3	CIP serial number byte 3	BYTE	106
CIP_SERIAL_4	CIP serial number byte 4	BYTE	107
BOOTROM_VERSION_1	Bootrom version byte 1	BYTE	108
BOOTROM_VERSION_2	Bootrom version byte 2	BYTE	109
BOOTROM_VERSION_3	Bootrom version byte 3	BYTE	110
BOOTROM_VERSION_4	Bootrom version byte 4	BYTE	111
CONFIG_FILE_1	Config file version byte 1	BYTE	112
CONFIG_FILE_2	Config file version byte 2	BYTE	113
EIP_VERSION_1	Eip version byte 1	BYTE	114
EIP_VERSION_2	EIP version byte 2	BYTE	115
ConNumber	Number of current connections	BYTE	116
CpuFree	Available CPU resource	BYTE	117
Mac_1	Mac Address byte 1	BYTE	118
Mac_2	Mac Address byte 2	BYTE	119

Status Name	Meaning/Description	Data Type	Byte Offset
Mac_3	Mac Address byte 3	BYTE	120
Mac_4	Mac Address byte 4	BYTE	121
Mac_5	Mac Address byte 5	BYTE	122
Mac_6	Mac Address byte 6	BYTE	123
HardwareVersion	Hardware version	BYTE	124
CpldVersion	Cpl Version	BYTE	125
RotaryLower	Rotary Lower	BYTE	126
RotaryUpper	Rotary Upper	BYTE	127
CurrentIPProvide	Current IP address comes from : 0 : <i>ipsError</i> 1 : <i>ipsDHCP</i> 2 : <i>ipsFactory</i> 3 : <i>ipsFromFlash</i> 4 : <i>ipsNoIP</i>	BYTE	128
PlcState	Main Plc connection state : 2: PLC_OFF 3: PLC_PROG 4: PLC_RUN	BYTE	129
PFBState	Profibus state : 1: PFB_OFFLINE 2: PFB_STOP 3: PFB_OPERATE. 4: PFB_CLEAR 5: PFB_SLAVE	BYTE	130
PB3Mode	SST-PB3-REM state : 1: PB3_MASTER 2: PLC_NO_CONF 3: PB3_SLAVE	BYTE	131
Port1_AutoNegociate (*)	(0=no, 1=yes)	BYTE	132
Port1_CurrentSpeed (*)	0: no link 10: 10 Mbps 100 : 100 Mbps	BYTE	133
Port1_CurrentDuplex (*)	(1=half, 2=full)	BYTE	134

Status Name	Meaning/Description	Data Type	Byte Offset
Port2_AutoNegociate (*)	(0=no, 1=yes)	BYTE	135
Port2_CurrentSpeed (*)	0: no link 10: 10 Mbps 100 : 100 Mbps	BYTE	136
Port2_CurrentDuplex (*)	(1=half, 2=full)	BYTE	137

Raw Data access example

Raw Data address will be in the format as [Module Name]:[CIP#]:S.Data[x], x is the Raw data byte offset. For example if the module name is PB3_REM_R and the register to access is PfbMasSts (3rd register below) then the raw data address would be **PB3_REM_R:0:S.data[4]**.

6.3 Making Changes to the Configuration Assembly

If the module is configured in Master or Master/Slave mode the procedure below describes the steps required for making changes in configuration assembly 131.

1. Put the controller into PROG mode.
2. Connect to the module from the SST™ Profibus Configuration Tool.
3. If the module is Online on the Profibus network, issue the Offline command from the configuration tool.
4. Edit the Configuration Assembly 131 for connection 1, see Table 6.1-6: Assembly 131 for details.
5. Download the controller program.
6. Disconnect the module from the configuration tool.
7. Put the controller into RUN.

7

System Diagnostics

Chapter Sections:

- Profibus Status Register
- Diagnostic Counters

7.1 Profibus Status Register

The first 16-bit INT in the SST-PB3-REM status UDT (see 5.5.1, Master Configuration UDT) is the module Status register (PfbStatus). The following tables show possible status register values.

Table 7.1-1: PfbStatus (Raw data byte offset = 0)

Status Name	Meaning/Description	Value
STS_NO_ERROR	The SST-PB3-REM has no errors	0x0000
STS_BAD_BAUD	The configured baud rate is not valid	0x0002
STS_BAD_STN_ADR	The configured station address is not valid	0x0003
STS_BAD_HI_STN_ADR	The configured Highest Station Address is not valid	0x0004
STS_CFG_INTERNAL_ERROR	The SST-PB3-REM has encountered a fatal internal error	0x0080
STS_OUT_OF_APBS	The SST-PB3-REM has run out of internal resources	0x0081
STS_HEAP_ALLOC_FAIL	The SST-PB3-REM has run out of internal resources	0x0083
STS_SH_HEAP_ALLOC_FAIL	The SST-PB3-REM has run out of internal resources	0x0084

If the status register contains STS_CFG_INTERNAL_ERROR (80h), there has been an internal error on the SST-PB3-REM. Record the contents of the ErrInternal and errArg registers and contact [Technical Support](#). ErrInternal is stored in the high byte of status area offset 24. ErrArg is stored in the low byte of status area offset 25.

If the status register contains STS_OUT_OF_APBS (81h), the SST-PB3-REM has run out of application blocks. The DP master uses 2 application blocks per configured slave. There are a total of 835 application blocks. If you get this error, reduce the number of application blocks you use.

If the status register contains STS_HEAP_ALLOC_FAIL (83h) or STS_SH_HEAP_ALLOC_FAIL (84h), there has been an internal error in allocating memory. Contact [Technical Support](#).

Table 7.1-2: PfbMasSts (DP Master Global Status) (Raw data byte offset = 4)

Status Name	Meaning/Description	Value
PFB_MAS_STS_ALL_OK	All the configured DP slave devices are online and operating	0x01
PFB_MAS_STS_ALL_NOT OK	At least one DP Slave is not configured or not present on the bus	0x00

Table 7.1-3: PfbMasCntrlCfg (Raw data byte offset = 7)

Status Name	Meaning/Description	Value
PFB_MAS_CTRL_SYNC_SCAN	Sync Scan mode is enabled	0x01
PFB_MAS_CTRL_RUN_MODE	The DP Bus state is Run (Operate)	0x02
PFB_MAS_CTRL_USR_OFS	The DP slave data addresses have been assigned to PLC memory	0x04
PFB_MAS_CTRL_ENABLE	DP Master mode is enabled	0x08
PFB_MAS_CTRL_ADDR_ASSIGNED	The DP slave data to PLC memory addresses are valid	0x80

7.1.1 Firmware Version Number

The version number of the SST-PB3-REM firmware is stored in status area offset 1. For example, if the Word corresponding to the value is 0122h, then the firmware is version 1.22.

7.1.2 DP Master Live List and Diagnostics List

There are two Slave Status tables available in the Status assembly 131 for PB3-REM. One is the Live List and contains one bit per slave. The other table is the Diagnostic List and it also contains one bit per slave.

For each of these two fields:

- Bit 0 corresponds to Profibus station address 0
- Bit x corresponds to Profibus station address x

Table 7.1-4: PfbLiveList and PfbDiagList

Active Station Group Tags	7	6	5	4	3	2	1	0
PfbLiveList[0] or PfbDiagList [0]	7	6	5	4	3	2	1	0
PfbLiveList [1] or PfbDiagList [1]	15	14	13	12	11	10	9	8
PfbLiveList [2] or PfbDiagList [2]	23	22	21	20	19	18	17	16
PfbLiveList [3] or PfbDiagList [3]	31	30	29	28	27	26	25	24
PfbLiveList [4] or PfbDiagList [4]	39	38	37	36	35	34	33	32
PfbLiveList [5] or PfbDiagList [5]	47	46	45	44	43	42	41	40
PfbLiveList [6] or PfbDiagList [6]	55	54	53	52	51	50	49	48
PfbLiveList [7] or PfbDiagList [7]	63	62	61	60	59	58	57	56
PfbLiveList [8] or PfbDiagList [8]	71	70	69	68	67	66	65	64
PfbLiveList [9] or PfbDiagList [9]	79	78	77	76	75	74	73	72
PfbLiveList [10] or PfbDiagList [10]	87	86	85	84	83	82	81	80
PfbLiveList [11] or PfbDiagList [11]	95	94	93	92	91	90	89	88
PfbLiveList [12] or PfbDiagList [12]	103	102	101	100	99	98	97	96
PfbLiveList [13] or PfbDiagList [13]	111	110	109	108	107	106	105	104
PfbLiveList [14] or PfbDiagList [14]	119	118	117	116	115	114	113	112
PfbLiveList [15] or PfbDiagList [15]		126	125	124	123	122	121	120

Table 7.1-5: Live Slave List (Raw Data Addressing)

The SST-PB3-REM has been named PB3_REM_R and status connection is using CIP ID 0 in this addressing example.

Raw Data Address	Bit							
	7	6	5	4	3	2	1	0
PB3_REM_R:0:S.DATA[52]	7	6	5	4	3	2	1	0
PB3_REM_R:0:S.DATA[53]	15	14	13	12	11	10	9	8
PB3_REM_R:0:S.DATA[54]	23	22	21	20	19	18	17	16
PB3_REM_R:0:S.DATA[55]	31	30	29	28	27	26	25	24
PB3_REM_R:0:S.DATA[56]	39	38	37	36	35	34	33	32
PB3_REM_R:0:S.DATA[57]	47	46	45	44	43	42	41	40
PB3_REM_R:0:S.DATA[58]	55	54	53	52	51	50	49	48
PB3_REM_R:0:S.DATA[59]	63	62	61	60	59	58	57	56
PB3_REM_R:0:S.DATA[60]	71	70	69	68	67	66	65	64
PB3_REM_R:0:S.DATA[61]	79	78	77	76	75	74	73	72
PB3_REM_R:0:S.DATA[62]	87	86	85	84	83	82	81	80
PB3_REM_R:0:S.DATA[63]	95	94	93	92	91	90	89	88
PB3_REM_R:0:S.DATA[64]	103	102	101	100	99	98	97	96
PB3_REM_R:0:S.DATA[65]	111	110	109	108	107	106	105	104
PB3_REM_R:0:S.DATA[66]	119	118	117	116	115	114	113	112
PB3_REM_R:0:S.DATA[67]		126	125	124	123	122	121	120

Table 7.1-6: Slave Diagnostic List (Raw Data Addressing)

Raw Data Address	Bit							
	7	6	5	4	3	2	1	0
PB3_REM_R:0:S.DATA[68]	7	6	5	4	3	2	1	0
PB3_REM_R:0:S.DATA[69]	15	14	13	12	11	10	9	8
PB3_REM_R:0:S.DATA[70]	23	22	21	20	19	18	17	16
PB3_REM_R:0:S.DATA[71]	31	30	29	28	27	26	25	24
PB3_REM_R:0:S.DATA[72]	39	38	37	36	35	34	33	32
PB3_REM_R:0:S.DATA[73]	47	46	45	44	43	42	41	40
PB3_REM_R:0:S.DATA[74]	55	54	53	52	51	50	49	48
PB3_REM_R:0:S.DATA[75]	63	62	61	60	59	58	57	56
PB3_REM_R:0:S.DATA[76]	71	70	69	68	67	66	65	64
PB3_REM_R:0:S.DATA[77]	79	78	77	76	75	74	73	72
PB3_REM_R:0:S.DATA[78]	87	86	85	84	83	82	81	80
PB3_REM_R:0:S.DATA[79]	95	94	93	92	91	90	89	88
PB3_REM_R:0:S.DATA[80]	103	102	101	100	99	98	97	96
PB3_REM_R:0:S.DATA[81]	111	110	109	108	107	106	105	104
PB3_REM_R:0:S.DATA[82]	119	118	117	116	115	114	113	112
PB3_REM_R:0:S.DATA[83]		126	125	124	123	122	121	120

The PfbLiveList and the PfbDiagList flags are managed only for configured devices (class 1 communication) and are valid only when the Profibus stack is in OPERATE or CLEAR states. Otherwise, all bits will be set to 0.

For each device, the two bits must be interpreted as follows:

Table 7.1-7: PfbLiveList and PfbDiagList Definition

PfbLiveList	PfbDiagList	Meaning
0	0	This state is reported in the three following cases: <ul style="list-style-type: none"> - system init state (temporary state) - for not configured devices, as a definitive state - for configured devices, when the Profibus stack is not in OPERATE or CLEAR state
0	1	Communication with the device is failed
1	0	Communication with the device is OK and there is no diagnostic asked by the device
1	1	Communication with the device is OK but there is a diagnostic asked by the device

In addition, if the status of all slaves is acceptable, then bit 0 of location PfbMasSts is set to 1. If this bit is 0, one or more slaves are in error.

7.1.3 Reading the Slave Diagnostics

Refer to section 10, Explicit Messaging on how Slave Diagnostics are retrieved.

The first 6 slave Diagnostic bytes are common to all DP slaves, as follows:

Table 7.1-8: Response to Slave Diagnostic CIP Message

Location byte offset	Meaning/Description
1	Station status byte 1
2	Station status byte 2
3	Station status byte 3
4	Master Station Address (Master that configured the slave. OxFF means that no master has configured this slave)
5 – 6	Slave ID

The bits in station status byte 1 are defined in the table below.

Table 7.1-9: Bits in Station Status Byte 1

Bit	AOP Tag Name	Meaning/Description
7	Master Lock	DP slave has been parameterized by another master
6	Parameter_Fault	Slave received an invalid parameter frame, wrong Ident, wrong length, invalid parameters, and so on
5	Invalid_Slave_Repsonse	Invalid response from the slave
4	Function_Not_Supportedt	Master requested a function that the slave does not support
3	ExtDiagnosticData	An entry exists in the slave-specific diagnostic area.
2	CfgDataFalt	Configuration check data for the slave was incorrect

1	SlaveNotReady	Slave is not ready for data transfer
0	SlaveNonExistent	DP slave non-existent

The station status byte 1 should always be zero (0) when the master is scanning the slave. Otherwise, a non-zero value indicates errors.

The bits in station status byte 2 are defined in the table below.

Table 7.1-10: Table 3: Bits in Station Status Byte 2

Bit	AOP Tag Name	Meaning/Description
7	Deactivated	Slave has been marked inactive by the master
6	Reserved	Reserved
5	Sync_Command_Received	The slave has received a Sync command
4	Freeze_Command_Received	The slave has received a freeze command
3	Watchdog_On	The slave watchdog has been activated
2	Dp_Slave_Set	The slave has set this bit to 1
1	Static_Diagnostics	The slave is requesting a diagnostic read
0	Param_Config_RequiredSlaveReParam	The slave is requesting reparameterization

Station status byte two is 0x0C when the master is scanning a DP slave.

The bits in Station status byte 3 are defined in the table below.

Table 7.1-11: Table 3: Bits in Station Status Byte 3

Bit	AOP Tag Name	Meaning/Description
7	Ext_Diag_Overflow	The DP slave is returning more diagnostic information than the DP Master can enter in its diagnostic buffer
0-6	Reserved6 – SlaveReserved0	Reserved

7.2 Diagnostic Counters

The SST-PB3-REM maintains a variety of diagnostic counters to indicate:

- General statistics on messages sent and received
- The state of the master
- Network statistics

The counters are located in status assembly 161 and may be copied into the controller program using the copy data AOI provided in the L5X file exported from the SST™ Profibus Configuration Tool.

To reset these counters to 0, write 0x03 to the CMD Argument register (Assembly 121 byte offset 2) and then write 1 to Command control register (Assembly 111 byte offset 0) and then clear it to 0.

In the following table, counters with a name beginning with "diag" roll over to zero when they reach their maximum value. Counters with a name beginning with "err" hold their maximum value.

Table 7.2-1: Diagnostic Counters

Tag Name	Meaning/Description	Raw Data Byte Offset
ErrLanOffline	LAN went offline because of errors	8
DiagConf	Total confirmations (to requests from us)	10
DiagInd	Total indications	12
ErrNotOk	Total not OK confirmations and indications	14
DiagTokHldTime	Instantaneous token hold time	16
DiagMinTokHldTime	Minimum token hold time in Tbits	20
DiagMasterUpdate	Master I/O update cycles completed	24
ErrMasErr	Master->DP slave errors	26
ErrMasReConfig	Master->DP went offline and had to be reconfigured	27
DiagMasScanTime	Master scan time (us) in microseconds	28
DiagMasMaxScanTime	Maximum master scan time (us) in microseconds	32
ErrInvReqLen	Invalid request length errors	36
ErrFifo	FIFO overflow errors	37
ErrRxOverun	Receive overrun errors	38
ErrDbtTok	Double token errors (bad wiring or hardware)	39
ErrRespErr	Response errors (bad wiring or hardware)	40
ErrSyniErr	SYNI errors (bad wiring or hardware)	41
ErrNetTout	Network timeout errors	42
ErrHsa	Station higher than HSA was heard	43
ErrStn	Duplicate station detected	44
ErrPasTok	Unable to pass token (bad wiring or hardware)	45
ErrLasBad	Active station list invalid (bad wiring or hardware)	46

7.2.1 General Statistics

These counters relate to the overall operation of the SST-PB3-REM on the Profibus network.

The following is a list of general counter statistics:

- The ErrLanOffline counter increments when the LAN encounters errors and goes offline.
- The DiagConf counter counts total confirmations, that is, good replies to messages that this station has generated.
- The DiagInd counter counts total indications, that is, unsolicited messages to this station.
- The ErrNotOk counter counts the Total Not OK confirmations and indications, that is, total bad replies and bad unsolicited messages (indications).
- The DiagTokHldTime register stores the instantaneous token hold time, in Tbits. This is the time available to send messages when the SST-PB3-REM gets the token.
- The DiagMinTokHldTime register stores the minimum actual token hold time, in Tbits. This time is the minimum value of diagTokHldTime. If this number is 0, the target token rotation time in the Profibus configuration may need to be increased.

To increase the target token rotation time:

1. Open DP Master Configuration in the configuration tool.
2. Select and highlight Profibus.DP.
3. Right-click and select Properties from the shortcut menu that displays.
4. Select the Timing tab in the Network Dialog box.
5. Select the Token Rotation Time checkbox.
6. Enter the new value (the sum of all masters or Active Station's token rotation time) in the Token Rotation Time field.

7.2.2 DP Master Statistics

These counters relate to the operation of the SST-PB3-REM as a DP master.

The following is a list of DP Master Statistics:

- The DiagMasterUpdate counter is the number of Master I/O update cycles completed.
- The ErrMasErr counter is the number of DP master to DP slave communication errors. It increments anytime the message failed because of retries exceeded, and so on.
- The ErrMasReConfig counter is the number of times a DP slave went offline and had to be reconfigured, that is, the SST-PB3-REM was actively updating a node and got a faulty message.
- The DiagMasScanTime register contains the instantaneous master scan time in micro-seconds, that is, the time to scan all the slaves assigned to this master. The SST-PB3-REM adds 100 micro-seconds to the measured time to allow for overhead in starting the

timer, and so on.

- The DiagMasMaxScanTime registers contains the maximum value that DiagMasScanTime reached since it was last cleared

7.2.3 ASPC2 Profibus Controller Statistics

The ASPC2 LAN controller maintains the following counters, they are all 1 byte long. When these counters reach 255, they hold at 255 until cleared.

The ErrInvReqLen Counter

This register counts invalid request length errors. These errors occur when the SST-PB3-REM software gives the LAN controller a message that is too long. This is an internal error and should never occur.

The ErrFifo Counter

This register counts FIFO overflow errors. These errors occur when the LAN controller cannot write to memory fast enough. This is an internal error and should never occur.

The ErrRxOverrun Counter

This register counts receive overrun errors. This is an internal error and should never occur.

The ErrDbtTok Counter

This register counts double token errors. These errors may occur when more than one node thinks it has the token or there are wiring errors, duplicate nodes, and so on. The SST-PB3-REM withdraws to the “not hold token” state (decides it doesn't have the token) and waits until it gets the token passed to it again.

The ErrRespErr Counter

This register counts response errors when a message fails or there is no response from the destination. This error may be due to bad hardware or faulty wiring.

The ErrSyniErr Counter

This register indicates general network errors. These errors occur when there are problems on the network, but before you get a network timeout error.

The ErrNetTout Counter

This register counts network timeout errors. These errors occur when the network is dead. If a timeout occurs, the SST-PB3-REM enters the claim token state.

The ErrHsa Counter

This register increments when a station higher than the set high station address is heard. If the SST-PB3-REM is going online, it increments the counter and stays offline.

The ErrStn Counter

This register increments when a duplicate station is detected. If this error occurs when the SST-PB3-REM is going online, the module increments the errStn counter and stays offline.

The ErrPasTok Counter

This register increments when the SST-PB3-REM is unable to pass the token. This is usually caused by bad wiring (shorted) or other hardware problems. The module tries to pass the token, fails to hear its own token pass message, and puts itself offline.

The ErrLasBad Counter

This register increments when the active station list on the ASPC2 LAN controller is invalid because of multiple network errors. This error is caused by bad wiring or hardware.

8

Slave Functionality

Chapter Sections:

- DP Slave Features
- Status Assembly Entries
- Slave Configuration

8.1 DP Slave Features

The SST-PB3-REM DP Slave has the following features:

- A maximum of 244 bytes input and 244 bytes output.
- A maximum total input data size of 1996 bytes and output size of 1980 bytes for DP master and slave, combined.
- Support for all standard Profibus baud rates.
- Designated Exclusive Owner connection – different assembly instance numbers between Master/Slave or Slave Only mode (see [section 1.3](#), EtherNet/IP Assemblies).
- Configured via the configuration assembly. For Master/Slave mode the configuration assembly is 131 and for Slave-only mode the configuration assembly is 132.



Note

Caution should be exercised when configuring SST-PB3-REM as mixed DP-V0 Master and Slave. Once the module becomes active on the Profibus network, the user should observe the available CPU rate. If it drops below 10%, the user should consider increasing the scan cycle time of the Master scanning the SST-PB3-REM Slave. The available CPU rate may be retrieved either from the SST™ Profibus Configuration Tool ([section 4.8.10](#), Module Diagnostics), or from the Status assembly, CpuFree, [section 6.2](#), Input Only).

8.2 Status Assembly Entries

There are two entries in the structure mapped to the status assembly that support the DP slave functionality: slave status and slave error (see status assembly structure in [section 7.2](#), Input Only).

Table 8.2-1: DP Slave Status (SlvStatus) (Raw data offset = 86)

Bit	Meaning/Description
0 - 5	Reserved for future use.
6 (RUN MODE BIT)	Set to True if the slave is being scanned by a remote master in "RUN" mode.
7 (SLAVE OK BIT)	Set to True if the current slave status is OK. This means parameterization was successful and the slave watchdog has not timed out.

Table 8.2-2: DP Slave Error Byte (SlvError) (Raw data offset = 87)

Value	Error	Meaning/Description
01h	SLV_ERR_ID_MISM	Slave ID does not match the slave ID configured in the master. If there is a mismatch, the slave won't communicate with the master.
02h	SLV_ERR_READY_TIME_MISM	Ready time for the module is different from the value configured in the master. The module can communicate as a slave even if the times are different, but you may experience network errors.
03h	SLV_ERR_UNSUP_REQ	Master has requested Sync or Freeze during parameterization, which the module does not support.
04h	SLV_ERR_RX_LEN_MISM	Data received from the master has a length different from the length configured on the module. If there is a receive length mismatch, the module won't communicate as a slave.
05h	SLV_ERR_TX_LEN_MISM	Master has requested data from the slave with a length different from the length configured for the slave. If there is a transmit length mismatch, the module won't communicate as a slave.
06h	SLV_ERR_WD_FACT_INV	One of the two slave watchdog factors is zero, which is not allowed.
07h	SLV_ERR_TIME_OUT	Slave's watchdog timed out. The slave goes offline and must be reinitialized by the master.
08h	SLV_ERR_WARN_WD_DIS	Master has disabled the slave watchdog.



Note

All errors (except SLV_ERR_TIME_OUT) occur when the slave is being parameterized by the master.

8.3 Slave Configuration

To operate the SST-PB3-REM module in Master/Slave mode, in addition to the Exclusive Owner connections necessary to map the Profibus Master configuration, the user must also configure the slave Exclusive Owner connection, see Table 1.3-1: Exclusive Owner Connections. If the slave is configured but no corresponding connection is established, the module will fail to go online on the Profibus network.

When SST-PB3-REM operates in Master/Slave mode, the slave is configured via configuration assembly 131 of size 8, as seen in the table below:

Table 8.3-1: DP Slave Configuration Assembly 131

Byte	Value	Meaning/Description
2	0-244	Slave input length – must be an even number. If set to a value outside of range, the connection is rejected.
3	0-244	Slave output length – must be an even number. If set to a value outside of range, the connection is rejected.
4	0 or 1	Swap Words – if 1 words are swapped when copying data between Profibus and EtherNet/IP™. If 0 words are not swapped. If set to a value other than 0 or 1, the connection is rejected.



Note

If both bytes 2 (slave input length) and 3 (slave output length) are left at 0, the DP Slave functionality is not enabled on the module.



Note

When SST-PB3-REM is configured as Master/Slave it should be put online on the Profibus network from the controller and not from the SST™ Profibus Configuration Tool (this will only take the master configuration into account).

When SST-PB3-REM operates in Slave only mode the Slave only Exclusive Owner connection should be established, as seen in Table 2.3-1: Exclusive Owner Connections, The slave parameters are configured via configuration assembly 132 of size 6, as follows:

Table 8.3-2: DP Slave Configuration Assembly 132

Byte	Value	Meaning/Description
1	0 or 1	Autorun – if set to 1, the module becomes active on the Profibus network as soon as the Exclusive Owner connection with the controller is established. If set to a value other than 0 or 1, the connection is rejected.
2	0-244	Slave input length – must be an even number. If set to a value outside of range, the connection is rejected.
3	0-244	Slave output length – must be an even number. If set to a value outside of range, the connection is rejected.
4	0-125	Slave station number on the Profibus network. If set to a value outside of range, the connection is rejected.
5	0-11	Baud rate: 0 – 9.6 KBaud 1 – 19.2 KBaud 2 – 93.75 KBaud 3 – 187.5 KBaud 4 – 500 KBaud 6 – 1.5 MBaud 7 – 3 MBaud 8 – 6 MBaud 9 – 12 MBaud 10 – 31.25 KBaud 11 – 45.45 KBaud If set to a value outside of range, the connection is rejected.
6	0 or 1	Swap Words – if 1 words are swapped when copying data between Profibus and EtherNet/IP™. If 0 words are not swapped. If set to a value other than 0 or 1, the connection is rejected.

9

Explicit Messaging

Chapter Sections:

- General Overview of Explicit Messaging
- DP-V1 Explicit Messaging
- Sending an Explicit Message to SST-PB3-REM in RSLogix5000

9.1 General Overview of Explicit Messaging

The SST-PB3-REM Master contains three objects that can be accessed via explicit messaging. The first is the DP-V1 object which has a Class number of 0x64. The second object is the Command object which has a class number of 0x65. The third object is the EtherNet/IP Assembly object. These explicit messages can be sent to the SST-PB3-REM Master from a Rockwell Logix™ PLC such as CompactLogix or an EtherNet/IP Scanner.

9.1.1 Sending Explicit Messages to the DP-V1 Object

DP-V1 Object (Class Number 0x64, Instance 1, Attribute 0) – Allows the SST-PB3-REM to act on a Profibus network as a DP-V1 Class 1 & Class 2 master. The following explicit messages can be used to access this object.

Service Name	Service Code	Description
DP-V1 Class 1 Read	0x52	Reads data from DP-V1 Class 1 slave using slot and index parameters. See section 9.2.1, DP-V1 Class 1 Read Command.
DP-V1 Class 1 Write	0x53	Writes data to a DP-V1 slave using Slot Number and Index parameters See section 9.2.2, DP-V1 Class 1 Write Command.
DP-V1 Class 2 Initiate	0x54	Initiates a DP-V1 Class 2 connection to a slave. This must be done before DP-V1 Class 2 Reads and Writes are sent to Slave. See section 9.2.3, DP-V1 Initiate Command.
DP-V1 Class 2 Abort	0x55	Aborts a Class 2 connection. Note: Class 2 Abort is automatically sent when PLC goes to PROG or OFF state. See section 9.2.4, DP-V1 Class 2 Abort Command.
DP-V1 Class 2 Read	0x56	Reads data from a DP-V1 slave using Slot_Number and Index parameters through a Class 2 connection See section 9.2.5, DP-V1 Class 2 Read Command.
DP-V1 Class 2 Write	0x57	Writes data to a DP-V1 slave using Slot_Number and Index parameters through a DP-V1 Class 2 connection. See section 9.2.6, DP-V1 Class 2 Write Command.



Note

The firmware automatically initializes DP-V1 prior to going online.

As a DP-V1 Master the module is able to:

- Manage up to 16 simultaneous Class 1 commands and up to 16 simultaneous Class 2 commands.
- Manage up to 32 simultaneous Class 2 connections.

9.1.2 Sending Explicit Messages to the Command Object

Command Object (Class Number 0x65, Instance 1, Attribute 0)

The object allows the controller or EtherNet/IP Scanner to perform Profibus specific functions as below. The object can be accessed by using the following explicit messages:

Service Name	Service Code	Description
Get Slave Diagnostics	0x4b	Retrieve Diagnostics from a slave (maximum 244 diagnostic bytes)
Disable / Enable Slave	0x4c	Stop or Start data exchange with one or more slaves on Profibus network.
Set Slave Address	0x4d	Set the Profibus address of a slave.

9.1.3 Sending Explicit Messages to the Assembly Object

Assembly Object (Class Number 0x04, Instance xyz, Attribute 3)

The object allows a device without EtherNet/IP Scanner capability to read and write I/O data. The object can be accessed by using the following explicit messages:

Service Name	Service Code	Description
Set_Attribute_Single	0x10	Write I/O data and send commands to the module (Online, Offline, Run, Clear, Clear Network Counters), see Table 1.3-1: Exclusive Owner Connections for more details on assembly instances to use.

Get_Attribute_Single	0x0E	Read I/O and status data see Table 1.3-1: Exclusive Owner Connections for more details.
----------------------	------	---



Note

Writing to an assembly that belongs to an implicit connection will fail. Reading is always allowed.



Note

After writing a command, clear the command by first waiting for the Command Reply Register to echo the command and then write 0 to it. Clearing it to zero after will stop the console from executing the command when a command is executed in console.

9.1.4 Sending Explicit Messages to the Basic Diagnostics Object

Basic Diagnostics Object (Class Number 0x66, Instance 0 - 1, Attribute 0) – The object allows the controller or EtherNet/IP Scanner to read diagnostic information. The object can be accessed by using the following explicit message:

Service Name	Service Code	Description
Get_Attribute_All	0x01	Read the current state of SST-PB3-REM (see section 4.8.10, Module Diagnostics).

9.2 DP-V1 Explicit Messaging

9.2.1 DP-V1 Class 1 Read Command

This command reads data from a DP-V1 slave using Slot_Number and Index parameters.

In RSLogix5000 a MSG instruction of the CIP generic message type should be used.

Table 9.2-1: CIP Generic Message Parameters

Value	Message Parameter Name
0x64	Object
0x52	Service
1	Instance
8	Length

Source element: DPV1_READ_C1_REQ tag, with the following properties:

Table 9.2-2: Source Element

Value	Size	Member Name	Meaning/Description
	DINT	Timeout	Command timeout
[0...126]	SINT	Rem_Add	Slave address (0 to 126)
[0...254]	SINT	Slot_Number	Slot number where the data should be read (0 to 254)
[0...254]	SINT	Index	Index where the data should be read (0 to 254)
[1...240]	SINT	Data_Length	Number of byte to read (1 to 240)

Destination: DPV1_READ_C1_RES tag, with the following properties:

Table 9.2-3: Destination

Size	Member Name	Meaning/Description
SINT	Status	DP-V1 status
SINT[3]	Extended_Error	If not successful, Extended information
SINT	Data_Length	Number of bytes read (1 to 240)
SINT [1..240]	Data	Data read

The message error code can have the following values:

Table 9.2-4: Error Code

Value	General Status
00h	Successful
01h	Unknown command
02h	Invalid command data length
05h	FDL error (see extended error code)
06h	DP-V1 Error (see extended error code)
07h	Another command is already in progress for this slave / class 2 connection.
0Ah	Invalid remote address
0Ch	Invalid data length
0Fh	DP-V1 is not initialized
11h	Online state expected
13h	Invalid slave response
16h	No space left on command queue

9.2.2 DP-V1 Class 1 Write Command

This command writes data to a DP-V1 slave using Slot_Number and Index parameters.

In RSLogix5000 a MSG instruction of the CIP generic message type should be used.

Table 9.2-5: CIP Generic Message Parameters

Value	CIP Generic Message Parameter
0x64	Object
0x53	Service
1	Instance
[9...248]	Length

Source element: DPV1_WRITE_C1_REQ tag, with the following properties:

Table 9.2-6: Source Element

Value	Size	Member Name	Meaning/Description
-	DINT	Timeout	Command timeout
[0...126]	SINT	Rem_Add	Slave address (0 to 126)
[0...254]	SINT	Slot_Number	Slot number where the data should be read (0 to 254)
[0...254]	SINT	Index	Index where the data should be read (0 to 254)
[1...240]	SINT	Data_Length	Number of byte to read (1 to 240)
-	SINT [1...240]	Data	Data to be written

Destination: DPV1_WRITE_C1_RES tag with the following properties:

Table 9.2-7: Destination

Size	Member Name	Meaning/Description
SINT	Status	DP-V1 status
SINT[3]	Extended_Error	If not successful, Extended information
SINT	Data_Length	Number of bytes written (1 to 240)

The message error code can have the following values:

Table 9.2-8: Error Code

Value	Meaning/Description
00h	Successful
01h	Unknown command
02h	Invalid command data length
05h	FDL error (see extended error code)
06h	DP-V1 errors (see extended error code)

07h	Another command is already in progress for this slave / class 2 connection.
0Ah	Invalid remote address
0Ch	Invalid data length
0Fh	DP-V1 is not initialized
11h	Online state expected
13h	Invalid slave response
16h	No space left on command queue

9.2.3 DP-V1 Initiate Command

This command initiates a DP-V1 Class 2 connection to a slave.



Note

When using Class 2 communication only, up to 16 Class 2 connections can be initiated.

In RSLogix5000 a MSG instruction of the CIP generic message type should be used.

Table 9.2-9: CIP Generic Message Parameters

Value	Message Parameter Name
0x64	Object
0x54	Service
1	Instance
[33..244]	Length

Source element: DPV1_INITIATE_REQ tag, with the following properties:

Table 9.2-10: Source Element

Member Name	Size	Offset	Meaning/Description
Timeout	DINT	0000h	Time allowed for message reply in milliseconds.
Rem_Add	SINT	0004h	Slave Address (0 to 126).
Send_TimeOut	INT	0005h	Time expected, in 10ms.
Features_Supported	INT	0007h	Features supported by the master.
Profile_Features_Supported	INT	0009h	Service functionality supported by the master.
Profile_Ident_Number	INT	000Bh	Desired profile ID number (0 = no profile)
Add_Addr_Param	SINT[20 + x + y]	-	Subnet parameters
STYPE	SINT	000Dh	0 or 1; if STYPE = 1 the optional Net_addr and Mac_addr is present in S_Addr.
S_Addr_len	SINT	000Eh	Length of the S_Addr : if STYPE = 0, the S_Addr_Len = 2 if STYPE = 1, the S_Addr_Len = 8 + length of Mac_addr (x)
DTYPE	SINT	000Fh	0 or 1; if DTYPE = 1 the optional Net_addr and Mac_addr is present in D_Addr.
D_Addr_len	SINT	0010h	Length of the D_Addr : if DTYPE = 0, the D_Addr_Len = 2 if DTYPE = 1, the D_Addr_Len = 8 + length of Mac_addr (y)
S_Addr	SINT[8+x]	-	-
API	SINT	0011h	Application process instance
SCL	SINT	0012h	Access level
Net_addr	SINT[6]	0013h	Network address according to ISO/OSI-Network addresses
Mac_addr	INT[x]	0019h	MAC Address
D_Addr	SINT[8+y]	-	-
API	SINT	0019h + x	Application process instance
SCL	SINT	001Ah + x	Access level
Net_addr	SINT[6]	001Bh + x	Network address according to ISO/OSI-Network addresses
Mac_addr	INT[y]	0021h + x	MAC Address

Destination: DPV1_INITIATE_RES tag, with the following properties:

Table 9.2-11: Destination

Size	Member Name	Meaning/Description
SINT	Status	DP-V1 status
SINT[3]	Extended_Error	If not successful, Extended information
INT(*)	Send_TimeOut	Updated time by the slave in 10 ms unit
INT(*)	Features_Supported	Features supported by the slave.
INT(*)	Profile_Features_Supported	Service functionality supported by the slave
INT(*)	Profile_Ident_Number	Profile ID supported by the slave
SINT	C_Ref	Connection reference

(*) High byte is placed first. For example, for the Send_TimeOut word, you will find 0xF4 in 0x01, and 0x01 for a Send_TimeOut of 500 (0x01F4) in 0x02.

The message error code can have the following values:

Table 9.2-12: Error Code

Value	Meaning/Description
00h	Successful
01h	Unknown command
02h	Invalid command data length
05h	FDL (see extended error code)
06h	DP-V1 (see extended error code)
07h	Another command is already in progress for this slave / class 2 connection.
0Ah	Invalid remote address
0Fh	DP-V1 is not initialized
11h	Online state expected
12h	Invalid Add_Addr parameter
13h	Invalid slave response
14h	Could not manage more Class 2 connections
16h	No space left on command queue

9.2.4 DP-V1 Class 2 Abort Command

This command aborts a DP-V1 Class 2 connection.

In RSLogix5000 a MSG instruction of the CIP generic message type should be used.

Table 9.2-13: CIP Generic Message Parameters

Value	Message Parameter Name
0x64	Object
0x55	Service
1	Instance
7	Length

Source element: DPV1_ABORT_REQ tag, with the following properties:

Table 9.2-14: Source Element

Value	Size	Member Name	Meaning/Description
	DINT	Reserved	-
Returned by initiate	SINT	C_Ref	Connection reference
0	SINT	Subnet	Location of the source of the abort request
2	SINT	Instance_ReasonCode	Protocol instance and reason for the abort

Destination: none.

The message error code can have the following values:

Table 9.2-15: Error Code

Value	Meaning/Description
00h	Successful
01h	Unknown command
02h	Invalid command data length
07h	Another command is already in progress for this slave / class 2 connection.
0Bh	Invalid connection reference
0Fh	DP-V1 is not initialized
11h	Online state expected
15h	Class 2 connection is not initialized
16h	No space left on command queue

9.2.5 DP-V1 Class 2 Read Command

This command reads data from a DP-V1 slave using Slot_Number and Index parameters through a Class 2 connection.

In RSLogix5000 a MSG instruction of the CIP generic message type should be used.

Table 9.2-16: CIP Generic Message Parameters

Value	Message Parameter Name
0x64	Object
0x56	Service
1	Instance
8	Length

Source element: DPV1_READ_C2_REQ tag, with the following properties:

Table 9.2-17: Source Element

Value	Size	Member Name	Meaning/Description
	DINT	Timeout	Command timeout
-	SINT	C_Ref	Connection reference
[0...254]	SINT	Slot_Number	Slot number where the data should be read (0 to 254)
[0...254]	SINT	Index	Index where the data should be read (0 to 254)
[1...240]	SINT	Data_Length	Number of byte to read (1 to 240)

Destination: DPV1_READ_C2_RES tag, with the following properties:

Table 9.2-18: Destination

Size	Member Name	Meaning/Description
SINT	Status	DP-V1 status
SINT[3]	Extended_Error	If not successful, Extended information
SINT	Data_Length	Number of bytes read (1 to 240)
SINT [1..240]	Data	Data read

The message error code can have the following values:

Table 9.2-19: Error Code

Value	Meaning/Description
00h	Successful
01h	Unknown command
02h	Invalid command data length
05h	FDL error (see extended error code)

06h	DP-V1 Error (see extended error code)
07h	Another command is already in progress for this slave / class 2 connection.
0Ch	Invalid data length
0Fh	DP-V1 is not initialized
11h	Online state expected
13h	Invalid slave response
15h	Class 2 connection is not initialized
16h	No space left on command queue

9.2.6 DP-V1 Class 2 Write Command

This command writes data to a DP-V1 slave using Slot_Number and Index parameters through a DP-V1 Class 2 connection.

In RSLogix5000 a MSG instruction of the CIP generic message type should be used.

Table 9.2-20: CIP Generic Message Parameters

Value	Message Parameter Name
0x64	Object
0x57	Service
1	Instance
[9...248]	Length

Source element: DPV1_WRITE_C2_REQ tag, with the following properties:

Table 9.2-21: Source Element

Value	Size	Member Name	Meaning/Description
-	DINT	Timeout	Command timeout
-	SINT	C_Ref	Connection reference
[0...254]	SINT	Slot_Number	Slot number where the data should be read (0 to 254)
[0...254]	SINT	Index	Index where the data should be read (0 to 254)
[1...240]	SINT	Data_Length	Number of byte to read (1 to 240)
-	SINT [1...240]	Data	Data to be written

Destination: DPV1_WRITE_C2_RES tag, with the following properties:

Table 9.2-22: Destination

Size	Member Name	Meaning/Description
SINT	Status	DP-V1 status
SINT[3]	Extended_Error	If not successful, Extended information

SINT [1..240]	Data_Length	Number of bytes written (1 to 240)
------------------	-------------	------------------------------------

The message error code can have the following values:

Table 9.2-23: Error Code

Value	Meaning/Description
00h	Successful
01h	Unknown command
02h	Invalid command data length
05h	FDL error (see extended error code)
06h	DP-V1 error (see extended error code)
07h	Another command is already in progress for this slave / class 2 connection.
0Ch	Invalid data length
0Fh	DP-V1 is not initialized
11h	Online state expected
13h	Invalid slave response
15h	Class 2 connection is not initialized
16h	No space left on command queue

9.2.7 Extended Error Code

9.2.7.1 FDL Error (0xE5)

If an FDL error (0xE5) occurs, the extended error code contains the FDL error code.

The following table describes the meaning of the FDL_ErrorCode:

Table 9.2-24: FDL_ErrorCode Description

Value	Meaning/Description
0h	OK
1h	User error, SAP locked
2h	No resource for sending data, tried to send to SAP that was not configured
3h	No service available (SAP does not exist)
4h	Access point blocked
80h	Short character, problems with wiring, termination, etc
9Fh	No access
AFh	Double token detected, problems with wiring, termination, etc.
BFh	Response buffer too small
8Fh	Noise at SM command, problems with wiring, termination, etc.

9.2.7.2 DP-V1 Error (0xE6)

If a DP-V1 error (0xE6) occurs, the extended error code contains the DP-V1 error code, 3 bytes are significant:

- The first indicates the type of error (its value is always 0x80 : DP-V1 error)
- The second consists of two parts:
 - The highest four bits represent the error class
 - The lowest four bits represent the error code
- The third contains a slave-specific error code

The following table describes the meaning of the error class and error code of the second error byte.

Table 9.2-25: DP-V1 Errors

Error_Class	Meaning/Description	Error_Code
0 to 9	Reserved	
10=	Application	0 = read error 1 = write error 2 = module failure 3 to 7 = reserved 8 = version conflict 9 = features not supported 10 to 15 = user specific
11=	Access	0 = invalid index 1 = write length error 2 = invalid slot 3 = type conflict 4 = invalid area 5 = state conflict 6 = access denied 7 = invalid range 8 = invalid parameter 9 = invalid type 10 to 15 = user specific
12 =	Resource	0 = read constrain conflict 1 = write constrain conflict 2 = resource busy 3 = resource unavailable 4 to 7 = reserved 8 to 15 = user specific
13 to 15	User specific	

9.2.8 Get Slave Diagnostics

Send this explicit message to the SST-PB3-REM to retrieve diagnostic data for a specific slave.

In RSLogix5000 a MSG instruction of the CIP generic message type should be used.

Message Format:

- Send format = Slave number (BYTE), Clear Diagnostic (BOOL (8bit))

- Receive = Diagnostic data (size no greater than 244 bytes)

Table 9.2-26: CIP Generic Message Parameters

Value	CIP Generic Message Parameter
0x65	Object
0x4b	Service
1	Instance
0	attribute
2	Length

Table 9.2-27: Command Data

Value	Size	Parameter Name
[1...125]	SINT	Slave node number
0 or 1	SINT	0 = do not clear Diagnostics 1 = clear Diagnostics once read

Table 9.2-28: Response Data

Value	Size	Parameter Name
0 – Success 0x9f – FDL Error	SINT	Status
[1...244]	SINT	Number of diagnostic bytes
-	SINT[1-244]	Diagnostic data

9.2.9 Disable / Enable Slave

Send this explicit message to the Command Object to stop and start data exchange with one or more slaves.

In RSLogix5000 a MSG instruction of the CIP generic message type should be used.

Message Format:

- Array of 126 bytes with each byte representing a slaves node address
- Each byte may have the following values:
 - 0 Do Nothing
 - 1 Enable Slave
 - 2 Disable Slave
- If the length is less than 125 then the remaining nodes will assume “Do Nothing”
- If the write length is zero the EM returns the current state.

Table 9.2-29: CIP Generic Message Parameters

Value	CIP Generic Message Parameter
0x65	Object

0x4c	Service
1	Instance
0	attribute
126	Length

Table 9.2-30: Command Data

Value	Size	Parameter Name
[0 - 2]	SINT	For Node 0 0 = Do not change state 1 = Enable Slave 2 = Disable Slave
...	...	For Node n ...
[0 -.2]	SINT	For Node 125 0 = Do not change state 1 = Enable Slave 2 = Disable Slave

Response Data: N/A.

9.2.10 Set Slave Address

Send this explicit message to the Command Object to set the Profibus station address of a slave. In RSLogix5000 a MSG instruction of the CIP generic message type should be used.

Table 9.2-31: CIP Generic Message Parameters

Value	CIP Generic Message Parameter
0x65	Object
0x4d	Service
1	Instance
0	attribute
5	Length

Table 9.2-32: Command Data

Value	Size	Parameter Name
0 - 126	SINT	Current Profibus address
0 - 126	SINT	New Profibus Address
0 - 0xFFFF	INT	Ident number
	SINT	Option

Table 9.2-33: Response Data

Value	Size	Parameter Name
0 – Success 0x9f – FDL Error Table	SINT	FDL status

9.2.11 Basic Diagnostics

Send this explicit message to the Diagnostic Object (Basic diagnostic) to get the current state of the SST-PB3-REM

In RSLogix5000 a MSG instruction of the CIP generic message type should be used.

Table 9.2-34: CIP Generic Message Parameters

Value	CIP Generic Message Parameter
0x66	Object
0x01	Get Attribute All Service
1	Instance
0	Attribute
0	Length

Command Data: N/A.

Table 9.2-35: Response Data

Id	Offset	size	Name	Description
1	0	4	dwFirmwareVersion	Firmware version
2	4	4	dwBootromVersion	Boot Rom Version
3	8	4	dwCIPSerialNumber	CIP Serial number
4	12	4	byIsConfigFilePresent	Configuration file presence
5	16	4	dwCrcIOMapping	CRC IO mapping / Reserved
6	20	4	dwCrcConfigFile;	CRC configuration file
7	24	4	dwIp	IP Address
8	28	4	dwMask	Subnet mask
9	32	4	dwGateway	Default gateway
10	36	2	wConfigFileVersion	Configuration file version
11	38	2	wEipInterface	Eip interface version
12	40	2	wSupportedConfFileVer	Supported configuration file version
13	42	2	wComDtmConnection	Number of ComDTM connection

14	44	2	wCpuRateAvailable	Available Cpu Rate
15	46	6*1	byMacAddress	MAC Address
16	52	1	byHardwareVersion	PB3 hardware version
17	53	1	byCpldVersion	CPLD version
18	54	1	byRotaryLower	Rotary lower position
19	55	1	byRotaryUpper	Rotary upper position
20	56	1	byCurrentIpProvide	Current IP address. 0 : ipsError 1 : ipsDHCP 2 : ipsFactory 3 : ipsConfigFile 4 : ipsNoIP
21	57	1	byRebootIsNeeded	Reboot needed, one reason refuses the reboot, the reboot is ask by the module.
22	58	1	byPlcState	PLC_OFF PLC_PROG PLC_RUN
23	59	1	byPFBState	PFB_OFFLINE PFB_STOP PFB_CLEAR PFB_OPERATE. PFB_SLAVE
24	60	1	byPB3Mode	PB3_MASTER PB3_SLAVE PLC_NO_CONF
25	61	32	Reserved	Free space.

9.3 Sending an Explicit Message to SST-PB3-REM in RSLogix5000

This chapter describes how to create a Generic CIP Message for sending an Explicit Message to SST-PB3-REM in RSLogix5000 software.



Note

There is limit to the number of MSG (cache connection) instructions that may be left opened (cached) in RSLogix5000, see online help to find the limitations.

If using more than 16 MSG instructions in the ladder logic, we recommend that you disable the cache option for MSG instructions. For MSG instructions that only have to be executed once (i.e., DP-V1 Init and DP-V1 Class 2 Init commands) disabling the cache connection is recommended so that you can run more cache connection messages.

1. Select the MSG instruction from the Input/Output tab and place it into a rung of ladder code.

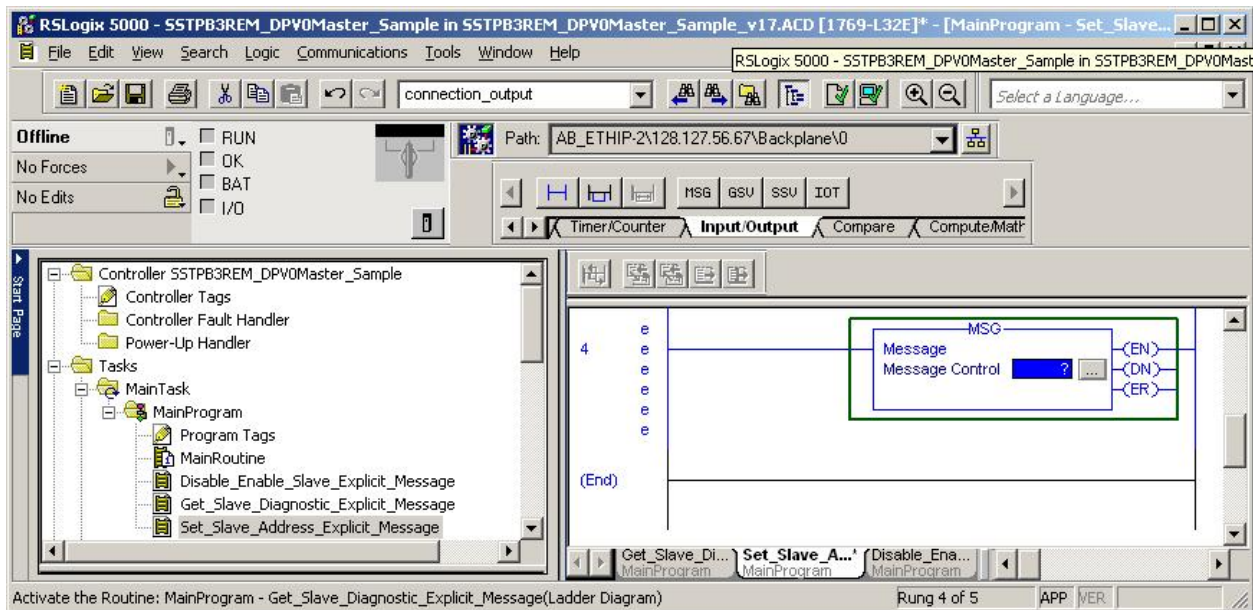

2. If you haven't already created a tag for the message, right-click on Message Control inside the MSG instruction and select the Create Tag. The New Tag dialog box displays.

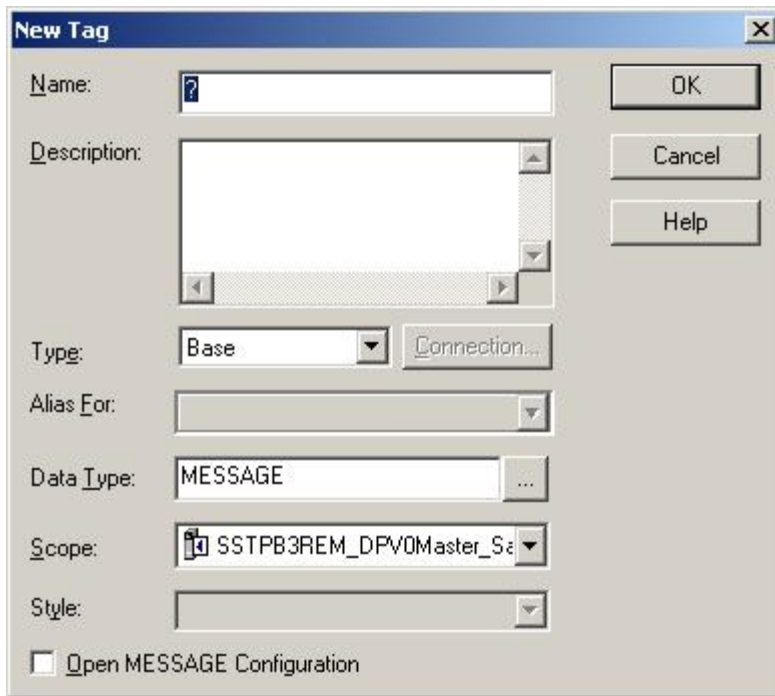

The 'New Tag' dialog box is shown with the following fields and options:

- Name:** A text field containing a question mark '?'.
- Description:** A large text area for entering a description.
- Type:** A dropdown menu set to 'Base' with a 'Connection...' button next to it.
- Alias For:** An empty dropdown menu.
- Data Type:** A text field containing 'MESSAGE' and a browse button '...'.
- Scope:** A dropdown menu set to 'SSTPB3REM_DPVOMaster_Sa'.
- Style:** An empty dropdown menu.
- Open MESSAGE Configuration**
- Buttons:** 'OK', 'Cancel', and 'Help' are located on the right side of the dialog.

3. Enter a unique tag name in the Name field and click OK.
4. Select Configure button as highlighted below in MSG instruction.

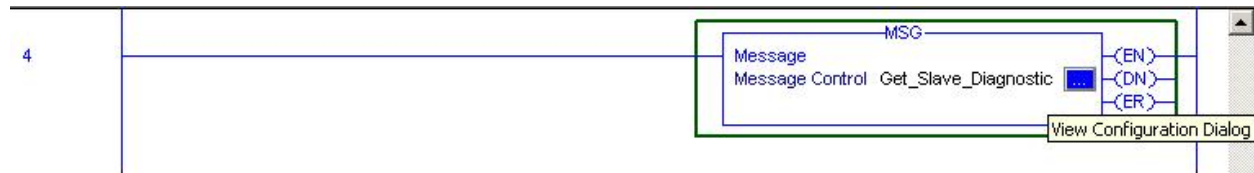

5. The Message Configuration dialog opens:

The screenshot shows the 'Message Configuration - Get_Slave_Diagnostic' dialog box. It has three tabs: 'Configuration', 'Communication', and 'Tag'. The 'Configuration' tab is active. The 'Message Type' dropdown is set to 'CIP Generic'. The 'Service Type' dropdown is set to 'Custom'. The 'Source Element' dropdown is empty. The 'Source Length' spinner is set to '1' with '(Bytes)' next to it. The 'Service Code' field is empty with '(Hex)' next to it. The 'Class' field is empty with '(Hex)' next to it. The 'Destination' dropdown is empty. The 'Instance' field is empty. The 'Attribute' field is empty with '(Hex)' next to it. There is a 'New Tag...' button. Below the configuration fields are several radio buttons: 'Enable', 'Enable Waiting', 'Start', and 'Done'. To the right of these is 'Done Length: 0'. There are also 'Error Code:', 'Extended Error Code:', and a 'Timed Out' checkbox. At the bottom are 'Error Path:' and 'Error Text:' labels. At the very bottom are 'OK', 'Cancel', 'Apply', and 'Help' buttons.

6. Under the Configuration tab, enter the following information:

Message Type:	CIP Generic
Service Code:	Specify the service code to that applies to the object you want to access.
Class:	Specify which object to access.
Instance:	Instance depends on which class used
Attribute:	Attribute depends on which class used
Source Element:	Select the variable source you created to hold the request
Source Length:	Select the number of bytes to transfer from the variable source
Destination:	Select the destination variable you created to hold the response

7. Under the Communication tab, select the Browse button to setup the path to where the message is to be sent to.

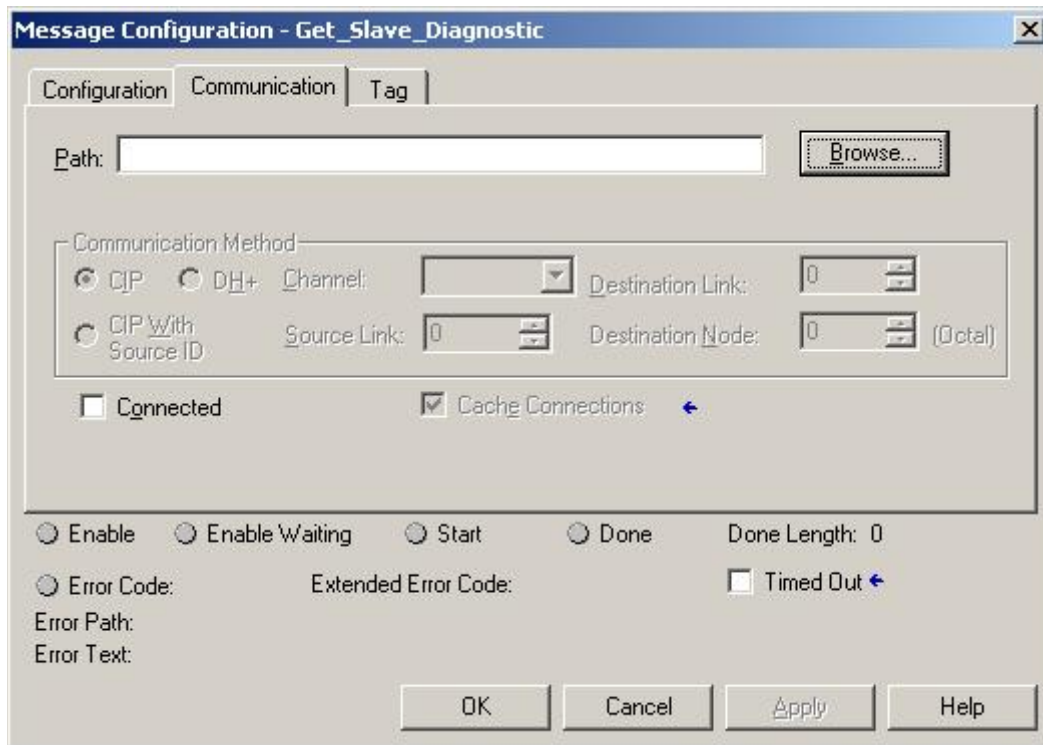

8. Select the Ethernet Bridge that was setup for SST-PB3-REM.

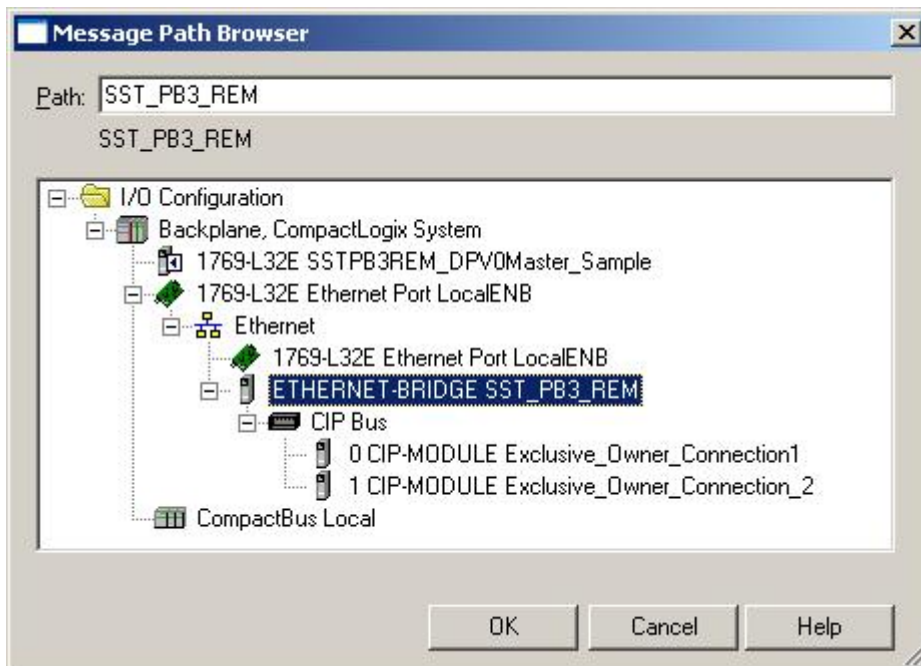

9. Click OK to return to the Communications Dialog box.
10. Under the Communication tab, select Connected to indicate whether the message should be sent as connected or unconnected.

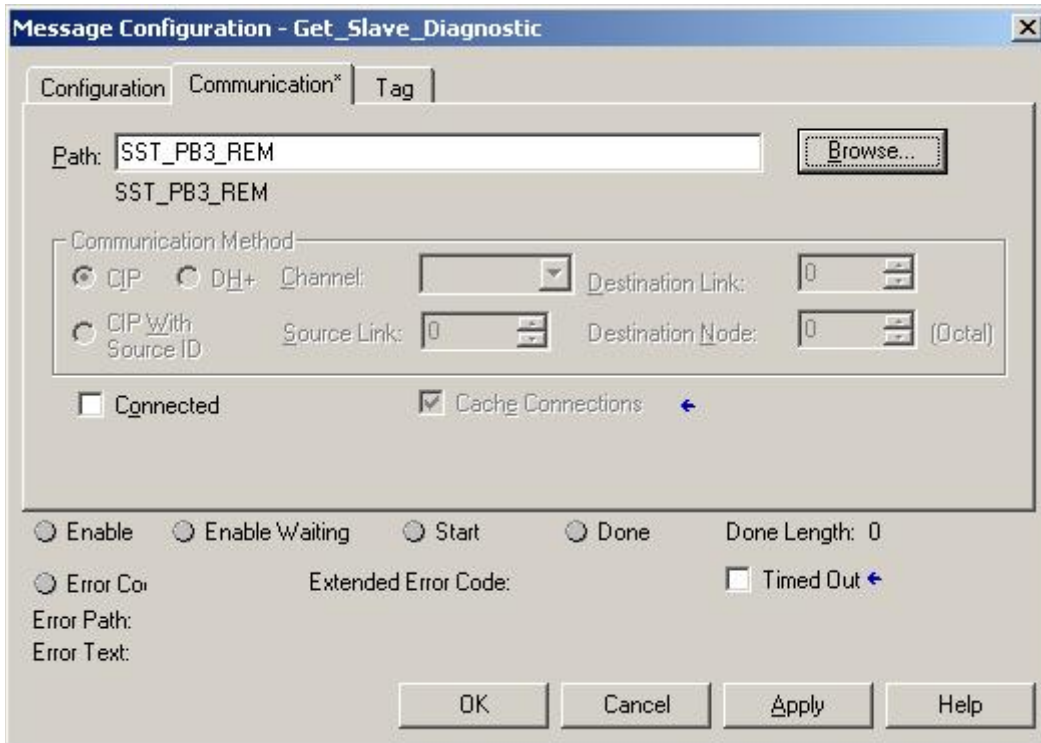

11. Click OK to close the dialog box.
12. If you are disabling the cache connection, go to Controller tags > Message Tag and set the Message Tagname: EN_CC to 0. The Message tagname in this example is Get_Slave_Diagnostic.

10

RSLogix5000 Ladder Samples

Chapter Sections:

- Ladder Sample Overview
- DP-V0 Master Ladder Sample
- DP-V0 Slave Only Ladder Sample
- DP-V1 Class 1 and Class 2 Master Ladder Sample

10.1 Ladder Sample Overview

Three RSLogix5000 ladder samples are included in the installation. These were created in RSLogix5000 version 17. These are:

SSTPB3REM_DPV0MASTER_Sample.ACD

SSTPB3REM_DPSlaveOnly_Sample.ACD

SSTPB3REM_DPV1_C1_C2_Sample.ACD

10.2 DP-V0 Master Ladder Sample

The ladder sample describes how to use the module as a DP Master that includes the following:

1. How to setup the module as Ethernet Bridge and the required assembly instance numbers with maximum sizes.
2. How to use the AOIs and Master UDT (default name SST_PB3_REM_MASTER) exported with the L5X file from the SST™ Profibus Configuration Tool.
3. How to use explicit messaging to:
 - a. Retrieve diagnostic data from a specific slave (Get_Slave_Diagnostic).
 - b. Set the Profibus station address of a slave (Set_Slave_Address).
 - c. Disable / enable slaves in the master's scan list (Disable_Enable_Slave).

10.3 DP-V0 Slave Only Ladder Sample

This ladder sample describes how to use the module as a DP Slave only that includes the following:

1. How to setup the module as Ethernet Bridge and the required assembly instance numbers with maximum sizes.
2. How to use the CPS_SST_PB3-REM_SLAVE_ONLY AOI and SST-PB3-REM Slave UDT.

10.4 DP-V1 Class 1 and Class 2 Master Ladder Sample

This ladder sample describes how to use the module as a DP-V1 Class 1 and Class 2 Master that includes the following:

1. How to setup the module as Ethernet Bridge and the required assembly instance numbers with maximum sizes. How to send DP-V1 class 1 and class 2 commands using explicit messages UDT.

11

Troubleshooting

11.1 Troubleshooting

Here are some troubleshooting tips that can be used when running into some common issues.

1. The SF (System Fault LED) stays solid RED all the time and connection to the module is not possible.

The following can cause the above issue.

- a. An IP Address has not been successfully assigned to module. The default state out-of-box mode is DHCP. This means an IP address has to be assigned to module by DHCP server successfully before the module will initialize successfully.

ACTION:

If Rockwell software is installed, BOOTP-DHCP Server can be used to assign an IP Address. When the MAC ID of the SST-PB3-REM appears, select it and assign an IP address.

- b. Duplicate IP Address has been detected on network. The SF LED will remain solid RED and a reboot of module is required.

ACTION:

Reboot and assign a new IP address to module. If the module has been assigned a static IP address that is already occupied and it needs to be changed, the module can be reset to the factory defaults by doing the following:

- a) Turn power off to module.
- b) Turn lower switch to E Position. This will restore the factory settings (DHCP, No Profibus Configuration).
- c) Turn power on to module.
- d) Wait until the Status LED on Ethernet Port 1 flashes 6 times repeatedly.
- e) Turn power off to module and set lower switch back to C position. Leaving the lower switch in C position will allow static IP address to be saved in flash.
- f) Turn power on to module.
- g) Wait until the Status LED on Ethernet Port 1 flashes 3 times repeatedly.

- h) Assign a unique IP address to module using DHCP server or Rockwell's BOOTP-DHCP Server.
 - i) The SF LED should turn from Solid RED to Flashing RED which indicates there is no Profibus configuration saved on module.
 - j) Connect to the module with SST Profibus Configuration tool and assign a static IP Address and download Master configuration to module.
2. The Module as a Master will not enter Profibus OPERATE state mode. It stays in CLEAR mode while PLC is in RUN mode.

The following can cause the above issue:

- a. The Ethernet/IP connections configured on module do not match what is configured on the Controller (PLC). For example, if the module is being configured as a DP Master and the Profibus configuration requires 2 EO (Exclusive Owner) connections but there is only 1 EO connection configured on Ethernet controller.

ACTION:

- a) Open the Profibus master configuration in the SST Profibus Configuration Tool.
 - b) Double-Click on the SST-PB3-REM Master.
 - c) Go to Parameters tab to view the configured Ethernet/IP connections.
 - d) Compare the configured Ethernet/IP connections with the connections configured on Controller to make sure they match.
- b. Invalid values have been assigned to the configuration assembly or the size specified for the configuration assembly is incorrect.

ACTION:

Correct the assembly numbers and sizes as required on Controller side

- c. AutoRun is disabled and the RUN command (0x01) has not been sent to module.

ACTION:

- a) Write command 0x01 to the first byte of assembly 121 and clear it after seeing this command appear in module command reply area, offset 2 of assembly 111.

Or

- b) Enable AUTORUN by writing 1 to byte 1 of configuration assembly 131. This will automatically put the module into RUN when controller is in RUN.

12

Technical Specifications

Technical Specifications for the SST-PB3-REM Module:

Part Number	SST-PB3-REM
Function	Logix™ scanner for Profibus networks.
Description	<ul style="list-style-type: none"> • MPC8313 processor • 64MB DDR2 SDRAM • 16 MB of sectored flash memory for storage of program and configuration data • ASPC2 LAN controller
EtherNet/IP Interface	<p>5 CIP connections.</p> <p>SST-PB3-REM supports I/O data up to a maximum of 1996 input bytes and 1980 output bytes if configured with 10 I/O assemblies (5 CIP connections).</p> <p>500 bytes Status.</p>
	DP-V1 Class 1 & Class 2 Master via Explicit Messaging.
Environmental	Storage temperature -40°C to 85°C
	Operating temperature 0°C to 70°C
	Operating RH level 5% to 95%, non-condensing
	Pollution Degree 1 - no pollution or only non-conductive or non-corrosive pollution
Current Consumption	150mA @24 VDC

Part Number	SST-PB3-REM-CC
Function	Logix™ scanner for Profibus networks, conformal coated version.
Description	<ul style="list-style-type: none"> • MPC8313 processor • 64MB DDR2 SDRAM • 16 MB of sectored flash memory for storage of program and configuration data • ASPC2 LAN controller
EtherNet/IP Interface	<p>5 CIP connections.</p> <p>SST-PB3-REM supports I/O data up to a maximum of 1996 input bytes and 1980 output bytes if configured with 10 I/O assemblies (5 CIP connections).</p> <p>500 bytes Status.</p>
	DP-V1 Class 1 & Class 2 Master via Explicit Messaging.
Environmental	Storage temperature -40°C to 85°C
	Operating temperature -25°C to 70°C
	Operating RH level 5% to 95%, non-condensing
	Pollution Degree 1 - no pollution or only non-conductive or non-corrosive pollution
Current Consumption	150mA @24 VDC

13

CE Compliance

Marking of this equipment with the **CE** symbol indicates compliance with European Council Directive 2004/108/EC.



Warning

This is a Class A product. In a domestic environment, this product may cause radio interference, in which case you may be required to take adequate measures.



Caution

This equipment is neither designed for, nor intended for operation in installations where it is subject to hazardous voltages and hazardous current.



Note

To maintain compliance with the limits and requirements of the EMC Directive, it is required to use quality interfacing cables and connectors when connecting to this device. Refer to the cable specifications in the Hardware Guide for selection of cable types.

14

Warranty and Support

Chapter Sections:

- Warranty
- Reference Documents
- Technical Support
- Getting Help

14.1 Warranty

For warranty information, refer to

http://www.molex.com/images/woodhead/woodhead_limited_warranty.pdf.

14.2 Reference Documents

For...	Read this Document...	Document Number
General Profibus information	http://www.Profibus.com/	N/A
RSLogix5000 information	ControlLogix 5000 Controllers General Instruction Set Reference Manual	AB Publication number 1756-6.4.1 and 1756-RM003A-US-P

For more information on Profibus, refer to the following:

- Profibus standard DIN 19245, parts 1 and 3. Part 1 describes the low-level protocol and electrical characteristics. Part 3 describes the DP protocol.
- European standard EN 50170.
- ET 200 Distributed I/O system, 6ES5 998-3ES22.
- IEEE 518 Guide for the Installation of Electrical Equipment to minimize Electrical Noise Input to Controllers.

14.3 Technical Support

Please ensure that you have the following information readily available before calling for Technical Support:

- SST-PB3-REM type and serial number
- Computer's make, model, CPU speed and hardware configuration
- Operating system type and version
- Details of the problem you are experiencing: firmware module type and version, target network and circumstances that may have caused the problem

14.4 Getting Help

Technical support is available during regular business hours by telephone, fax or email. The Molex web site contains useful information that can be accessed by clicking the link below:

[Molex Support and Download](#)

- Downloads center
- Support Request Form
- Knowledge Base
- Worldwide technical support contacts